

PREMIUM (FG7B)

ABOVE-GROUND SOLAR COVER
REEL SYSTEM
ASSEMBLY INSTRUCTIONS

PLEASE READ ENTIRE INSTRUCTIONS CAREFULLY BEFORE PROCEEDING

Four Easy Steps:

If you need additional assistance, contact us at info@feherguard.com or call 905-876-4766 Monday to Friday 8:30 a.m. to 5:00 p.m. Eastern Time.

□ Trim cover to clear inside top edge of pool.

Leave an extra 4" (10 cm) on cover length if installing at mid-point or widest point to allow for fold (see Fig. 11)

REEL SYSTEMS COMPONENTS AND PREPARATION:

Getting started: Safety Glasses recommended

Tools required for assembly:

- Portable drill
- Tape measure
- Pencil and Scissors
- 1/4" Drill Bit

Ends & Hardware Parts List:

2 Ends (Tees)	2 Cones
2 Handles	2 Bearings
2 Plugs for 3" Tube Sets	
Hardware Kit:	10 Plastic Screws
20 Strap Plates	4 Wing nuts & bolts
10 - 26" Straps	25 Metal Self-Drilling Screws

STEP 1: SOLAR REEL PLACEMENT:

- A. On round pools, the reel should be located across the center of pool or off center with cover extensions folded in (see Fig.1). On oval or rectangular pools, locate the reel at widest point.
- B. First determine the potential placement of the post cones. **Cones must be level** and on outer side of top rail. Ensure adequate space under the rail to tighten the wing nuts (see Fig. 2) Cones will be attached after reel has been assembled.

Measure between inside flat edges of 2 cones.

Fig. 2

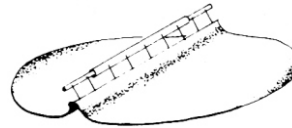
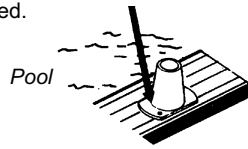

"Lift off and Swing"
Removal Feature

Fig. 1

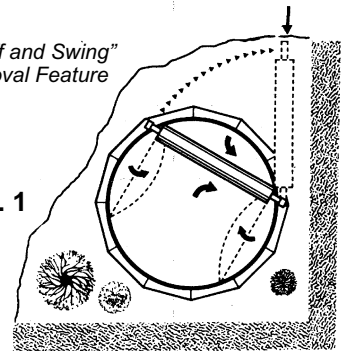

STEP 2: TUBE ASSEMBLY for L18, L18M*, L24M* (mill*) Tubeset

Note: THIS STEP REQUIRES A TOTAL OF 12 SELF-DRILLING SCREWS
Do not pre-drill holes or over-tighten screws.

- A. Carefully measure between inside flat edges of two cones to calculate overall length for the tubes. See Minimum Insertion Table below.



Fig. 3 Insert both end tubes equal distance into center tube and mark on center tube where inner tubes end

Tube	Min. Insert	Max. Width	Max. Wet Cover Weight	Max. Cover
L18/L18M*	9"	18'6" (5.7 m)	60# (27.3kg)	18x36
L24M*	13"	24'6" (7.3 m)	50# (22.7kg)	24'

- B. Lock tubes together by rotating the center tube in the opposite direction to end tube. **HOLD TUBES LOCKED WHILE YOU INSTALL FIRST SELF-DRILLING SCREW ON A DRILL LINE, 1" (2.5 cm) back from end of center tube at location "C1"** (Fig. 4 & 5).
- C. Place 2 more self-drilling screws at Location "C2" and "C3" - 1 screw at every second drill line around tubes (see Fig. 4).
- D. At "D" locations, install 3 screws around the center tube at every second drill line, 1" (2.5 cm) back from where you marked the end of the inner tube (see Fig. 4).
- E. Repeat for other end tube.

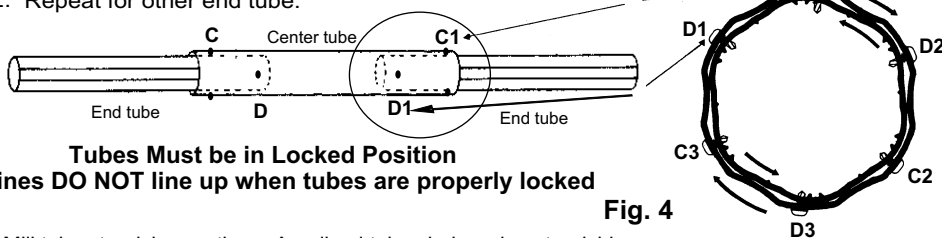

Fig. 4

Tubes Must be in Locked Position
Drill Lines DO NOT line up when tubes are properly locked

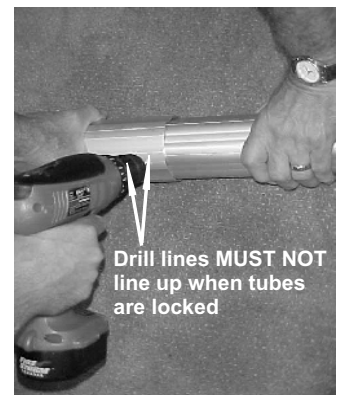

Fig. 5

* Mill tubes tarnish over time. Anodized tubes help reduce tarnishing.

Tube Assembly for L18/AG24EX or L18M/AG24EXM*, AGHD28, L28M* or IG30M*:

Note: Separate instructions are included in the tube cartons listed below

Assembly for Tube Sets below require 24 self-drilling screws EACH.

- **Twist, Lock and Hold EACH tube join before installing first screw.**

Do not pre-drill holes or over-tighten screws.

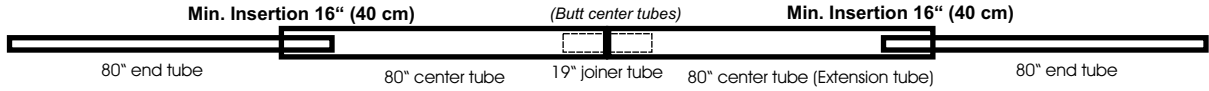

L18/AG24EX or L18M/AG24EXM* Maximum Extension 24' (7.3 m). Maximum Cover Weight 50# (22.7kg)

** Extra hardware and instructions are inside extension tube.

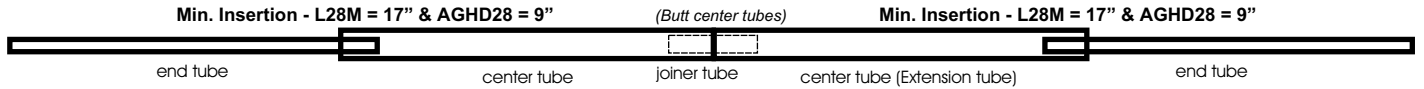

L28M*, AGHD28 or AGHD28M* Maximum Extension 28'6" (8.6 m). Maximum Cover Weight 50# (22.7kg)

** Extra hardware, instructions are included in tube set carton.

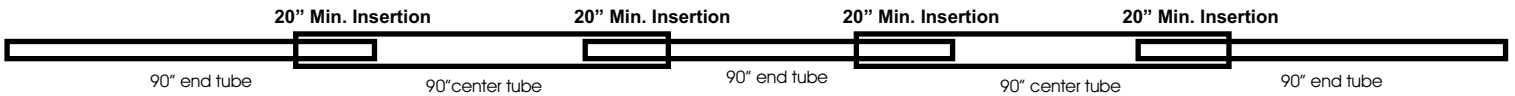

IG30M* Maximum Extension 30'6" (9.3 m) Round Pools. Maximum Cover Weight 50# (22.7kg)

** Extra hardware, instructions are included in tube set carton.

Fig. 6

* Mill tubes may tarnish over time. This does not affect performance. Anodized tubes help reduce tarnishing.

STEP 3: ASSEMBLE ENDS

Assemble in numerical order (see Fig. 7):

- Insert #1 appropriate Plug into End Tube.
- Place #2 Bearing inside #3 Tee.
- Push #4 Handle through Bearing and into Plug.
- Insert #5 self-drilling screw through tube in line with a bump on plug rim and 1" (2.5 cm) from tube end.
- Repeat for other end.

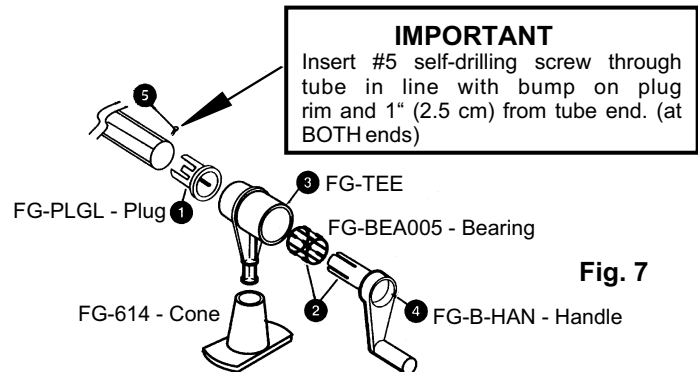

Fig. 7

STEP 4: STRAP ATTACHMENT

Attach a Strap Plate to EACH end of all Straps provided (see Fig. 8).

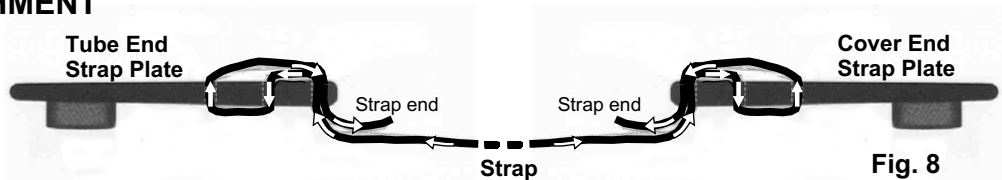

Fig. 8

STRAP ATTACHMENT - TO TUBES

- Mark each end tube 6" (15 cm) in from the inside edge of top rail of pool. Strap plates are spaced evenly between these marks. Mark strap plate locations along drill lines. Use all straps provided. Maximum distance between straps is 30"
- Attach strap plates to tube (see Fig. 9). **DO NOT pre-drill holes or over-tighten screw.**

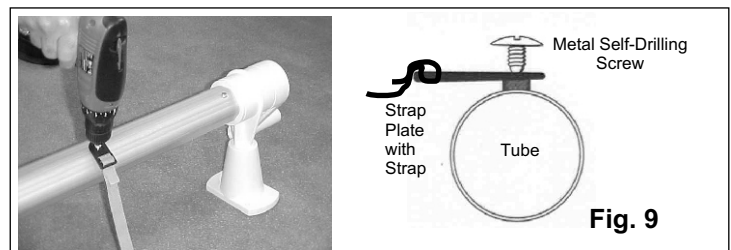

Fig. 9



STRAP ATTACHMENT - TO COVER

C. Choose the appropriate instructions below for your pool setup. If you have determined a mid-pool placement, it will be easier if you move the cover away from the pool and fold it (bubbles in) on a flat surface. Choose *EITHER* Fig. 10 *OR* Fig. 11.

For Reel Systems Placed at Pool End (Rectangular Pools) (Fig.10)

Fig. 10

Pierce hole through cover, 1" (2.5 cm) back from edge of cover and straight down (perpendicular) from a strap plate already attached to tube. Push threaded plastic screw through hole in cover then tighten snugly into plate. Repeat for remaining straps.

For Reel Systems placed at Mid-Pool (Round, Oval or Irregularly Shaped Pools) (Fig. 11)

Fig. 11

Fold cover where system will be placed (bubbles in). Pierce hole through both sides of cover, 1" (2.5 cm) back from the fold and straight down (perpendicular) from a strap plate already attached to tube. Push threaded plastic screw through holes in cover then tighten snugly into plate. Repeat for remaining straps.

D. Place assembled reel at the determined location and mark holes for post cones. Attach cones by drilling 1/4" (6.35 mm) holes in top rail as marked on the cones. **Do not drill into liner. Cones must be level** in order for the system to lift off or swing.

E. When you start to roll up the cover, all straps must take hold of the cover at the same time. Adjust the length of the straps as necessary.

Safe Use of Your Solar Reel:

Solar Reel Systems are designed solely to remove solar covers and are not made to support people or any other weight.

Solar covers must be completely removed before entry into the pool. Under no circumstances, should one swim in a pool partially covered with the solar cover.

Care and Storage:

Check screws periodically and tighten, if necessary. The solar reel may be stored outside for the winter. It is not recommended to disassemble it for storage

In order to protect the warranty on your solar cover, it is essential to use a protective cover when the it is rolled up on the reel. In the summer use a White Sheet with UV inhibitors and in Winter, a Winter Jacket. If not provided, they can be purchased from your pool retailer or by completing the enclosed order form.





Three Year Warranty:

FeherGuard warrants for a period of three years from the date of delivery to the original consumer purchaser, that the Premium Above Ground Solar Cover Reel System shall be free from defects in workmanship or material, under normal use and in accordance with FeherGuard's written installation and use instructions.

FeherGuard at its option shall supply free of charge any part found to be defective in workmanship or material.

Any implied warranties are limited in duration to the three-year period from the date of delivery to the original consumer purchaser. **Excluded from this warranty are all consumables (bearings, straps, strap plates, screws). Tarnishing or discoloration of mill aluminum tubes can occur. This is not a warranty issue as tarnishing does not affect tube performance.**

This warranty is void if there is evidence of purchaser abuse, improper installation or normal wear.

FeherGuard will not be liable for incidental or consequential damages resulting from any defects in workmanship or material, improper or unsafe storage and movement. Some States/Provinces/Countries do not allow the exclusion or limitation of incidental or consequential damages, so the foregoing limitations or exclusions may not apply.

This warranty gives the claimant specific legal rights. The provisions of this warranty are in addition to and not a modification of or a subtraction from the statutory warranties and other rights and remedies contained in applicable local legislation.

To validate warranty, return this registration form within 30 days of purchase. You may also register your warranty ONLINE at FeherGuard's Home Page - www.feherguard.com.

Warranty claims should be processed through your Dealer and include your proof of purchase.

FeherGuard Products Ltd. 3153 Steeles Ave. West, Unit 5
Milton, Ontario CANADA L9T 2V4
Specifications subject to change without notice. 12/10

Thank you for buying the Premium Above Ground Solar Cover Reel System. We know it will make solar cover handling easy for you.

 -----

FeherGuard "Three Year" Warranty Registration Please Print

PURCHASER: _____

ADDRESS: _____ CITY: _____

STATE/PROVINCE/COUNTRY: _____ ZIP/POSTAL CODE: _____

FG7B		
MODEL #	STORE LOCATION	PURCHASE DATE
