

XStream[™]

Owner's Manual



Contents

Product Warnings.....2
Introduction.....3
Installation.....3
Replacement Parts.....7
Warranty & Registration8

MODELS: CC1000, CC1500, and Systems

IMPORTANT SAFETY INSTRUCTIONS

Basic safety precautions should always be followed, including the following: Failure to follow instructions can cause severe injury and/or death.

 This is the safety-alert symbol. When you see this symbol on your equipment or in this manual, look for one of the following signal words and be alert to the potential for personal injury.

 **WARNING** warns about hazards that **could** cause serious personal injury, death or major property damage and if ignored presents a potential hazard.

 **CAUTION** warns about hazards that **will** or **can** cause minor or moderate personal injury and/or property damage and if ignored presents a potential hazard. It can also make consumers aware of actions that are unpredictable and unsafe.

The **NOTICE** label indicates special instructions that are important but not related to hazards.

Hayward Pool Products
620 Division Street, Elizabeth, NJ 07207
Phone: (908) 355-7995
www.hayward.com



▲ WARNING - Read and follow all instructions in this owner's manual and on the equipment. Failure to follow instructions can cause severe injury and/or death.

▲ WARNING – Suction Entrapment Hazard.



Suction in suction outlets and/or suction outlet covers which are, damaged, broken, cracked, missing, or unsecured can cause severe injury and/or death due to the following entrapment hazards:



Hair Entrapment- Hair can become entangled in suction outlet cover.



Limb Entrapment- A limb inserted into an opening of a suction outlet sump or suction outlet cover that is damaged, broken, cracked, missing, or not securely attached can result in a mechanical bind or swelling of the limb.



Body Suction Entrapment- A negative pressure applied to a large portion of the body or limbs can result in an entrapment.

Evisceration/ Disembowelment - A negative pressure applied directly to the intestines through an unprotected suction outlet sump or suction outlet cover which is, damaged, broken, cracked, missing, or unsecured can result in evisceration/ disembowelment.

Mechanical Entrapment- There is potential for jewelry, swimsuit, hair decorations, finger, toe or knuckle to be caught in an opening of a suction outlet cover resulting in mechanical entrapment.

▲ WARNING - To Reduce the risk of Entrapment Hazards:

- o When outlets are small enough to be blocked by a person, a minimum of two functioning suction outlets per pump must be installed. Suction outlets in the same plane (i.e. floor or wall), must be installed a minimum of three feet (3') [1 meter] apart, as measured from near point to near point.
- o Dual suction fittings shall be placed in such locations and distances to avoid “dual blockage” by a user.
- o Dual suction fittings shall not be located on seating areas or on the backrest for such seating areas.
- o The maximum system flow rate shall not exceed 6 ft/sec in the return line.
- o Never use Pool or Spa if any suction outlet component is damaged, broken, cracked, missing, or not securely attached.
- o Replace damaged, broken, cracked, missing, or not securely attached suction outlet components immediately.
- o In addition two or more suction outlets per pump installed in accordance with latest ASME, APSP Standards and CPSC guidelines, follow all National, State, and Local codes applicable.
- o Installation of a vacuum release or vent system, which relieves entrapping suction, is recommended.

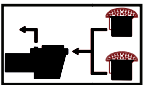

▲ WARNING – Failure to remove pressure test plugs and/or plugs used in winterization of the pool/spa from the suction outlets can result in an increase potential for suction entrapment as described above.

▲ WARNING – Failure to keep suction outlet components clear of debris, such as leaves, dirt, hair, paper and other material can result in an increase potential for suction entrapment as described above.

▲ WARNING – Suction outlet components have a finite life, the cover/grate should be inspected frequently and replaced at least every ten years or if found to be damaged, broken, cracked, missing, or not securely attached.

▲ CAUTION – Components such as the filtration system, pumps and heater must be positioned so as to prevent their being used as means of access to the pool by young children. To reduce risk of injury, do not permit children to use or climb on this product. Closely supervise children at all times. Components such as the filtration system, pumps, and heaters must be positioned to prevent children from using them as a means of access to the pool.



▲ WARNING – Hazardous Pressure. Pool and spa water circulation systems operate under hazardous pressure during start up, normal operation, and after pump shut off. Stand clear of circulation system equipment during pump start up. Failure to follow safety and operation instructions could result in violent separation of the pump housing and cover, and/or filter housing and clamp due to pressure in the system, which could cause property damage, severe personal injury, or death. Before servicing pool and spa water circulation system, all system and pump controls must be in off position and filter manual air relief valve must be in open position. Before starting system pump, all system valves must be set in a position to allow system water to return back to the pool. Do not change filter control valve position while system pump is running. Before starting system pump, fully open filter manual air relief valve. Do not close filter manual air relief valve until a steady stream of water (not air or air and water) is discharged.



▲ WARNING – Separation Hazard. Failure to follow safety and operation instructions could result in violent separation of pump and/or filter components. Strainer cover must be properly secured to pump housing with strainer cover lock ring. Before servicing pool and spa circulation system, filters manual air relief valve must be in open position. Do not operate pool and spa circulation system if a system component is not assembled properly, damaged, or missing. Do not operate pool and spa circulation system unless filter manual air relief valve body is in locked position in filter upper body.

Never operate or test the circulation system at more than 30 PSI. Do not purge the system with compressed air.

Purging the system with compressed air can cause components to explode, with risk of severe injury or death to anyone nearby. Use only a low pressure (below 5 PSI), high volume blower when air purging the pump, filter, or piping.



⚠ WARNING – Risk of Electric Shock. All electrical wiring **MUST** be in conformance with applicable local codes, regulations, and the National Electric Code (NEC). Hazardous voltage can shock, burn, and cause death or serious property damage. To reduce the risk of electric shock, do **NOT** use an extension cord to connect unit to electric supply. Provide a properly located electrical receptacle. Before working on any electrical equipment, turn off power supply to the equipment. To reduce the risk of electric shock replace damaged wiring immediately. Locate conduit to prevent abuse from lawn mowers, hedge trimmers and other equipment. Do **NOT** ground to a gas supply line.

⚠ WARNING – Risk of Electric Shock Failure to ground all electrical equipment can cause serious or fatal electrical shock hazard. Electrical ground all electrical equipment before connecting to electrical power supply.

⚠ WARNING – Risk of Electric Shock Failure to bond all electrical equipment to pool structure will increase risk for electrocution and could result in injury or death. To reduce the risk of electric shock, see installation instructions and consult a professional electrician on how to bond all electrical equipment. Also, contact a licensed electrician for information on local electrical codes for bonding requirements.

Notes to electrician: Use a solid copper conductor, size 8 or larger. Run a continuous wire from external bonding lug to reinforcing rod or mesh. Connect a No. 8 AWG (8.4 mm²) [No. 6 AWG (13.3 mm²) for Canada] solid copper bonding wire to the pressure wire connector provided on the electrical equipment and to all metal parts of swimming pool, spa, or hot tub, and metal piping (except gas piping), and conduit within 5 ft. (1.5 m) of inside walls of swimming pool, spa, or hot tub.

IMPORTANT - Reference NEC codes for all wiring standards including, but not limited to, grounding, bonding and other general wiring procedures.

⚠ WARNING – Risk of Electric Shock . The electrical equipment must be connected only to a supply circuit that is protected by a ground-fault circuit-interrupter (GFCI). Such a GFCI should be provided by the installer and should be tested on a routine basis. To test the GFCI, push the test button. The GFCI should interrupt power. Push reset button. Power should be restored. If the GFCI fails to operate in this manner, the GFCI is defective. If the GFCI interrupts power to the electrical equipment without the test button being pushed, a ground current is flowing, indicating the possibility of an electrical shock. Do not use this electrical equipment. Disconnect the electrical equipment and have the problem corrected by a qualified service representative before using.

⚠ CAUTION – HAYWARD® pumps are intended for use with permanently-installed pools and may be used with hot tubs and spas if so marked. Do not use with storable pools. A permanently-installed pool is constructed in or on the ground or in a building such that it cannot be readily disassembled for storage. A storable pool is constructed so that it is capable of being readily disassembled for storage and reassembled to its original integrity.

⚠ WARNING – Risk of Hyperthermia. To avoid hyperthermia the following “Safety Rules for Hot Tubs” are recommended by the U.S. Consumer Product Safety Commission.

1. Spa or hot tub water temperatures should never exceed 104°F [40°C]. A temperature of 100°F [38°C] is considered safe for a healthy adult. Special caution is suggested for young children. Prolonged immersion in hot water can induce hyperthermia.
2. Drinking of alcoholic beverages before or during spa or hot tub use can cause drowsiness, which could lead to unconsciousness and subsequently result in drowning.
3. Pregnant women beware! Soaking in water above 100°F [38°C] can cause fetal damage during the first three months of pregnancy (resulting in the birth of a brain-damaged or deformed child). Pregnant women should adhere to the 100°F [38°C] maximum rule.
4. Before entering the spa or hot tub, users should check the water temperature with an accurate thermometer; spa or hot tub thermostats may err in regulating water temperatures by as much as 4°F (2.2°C).
5. Persons taking medications, which induce drowsiness, such as tranquilizers, antihistamines or anti-coagulants, should not use spas or hot tubs.
6. If the pool/spa is used for therapy, it should be done with the advice of a physician. Always stir pool/ spa water before entering the pool/spa to mix in any hot surface layer of water that might exceed healthful temperature limits and cause injury. Do not tamper with controls, because scalding can result if safety controls are not in proper working order.
7. Persons with a medical history of heart disease, circulatory problems, diabetes or blood pressure problems should obtain a physician’s advice before using spas or hot tubs.
8. Hyperthermia occurs when the internal temperature of the body reaches a level several degrees above normal body temperature of 98.6°F [37°C]. The symptoms of Hyperthermia include: drowsiness, lethargy, dizziness, fainting, and an increase in the internal temperature of the body.

The effects of Hyperthermia include:

1. Unawareness of impending danger.
2. Failure to perceive heat.
3. Failure to recognize the need to leave the spa.
4. Physical inability to exit the spa.
5. Fetal damage in pregnant women.
6. Unconsciousness resulting in danger of drowning.

SAVE THESE INSTRUCTIONS



The Hayward® XStream™ Filtration Series is specifically designed for the demanding requirements of today's above-ground swimming pools. The advanced design reduces maintenance requirements while providing superior performance.

The XStream™ Filtration Series is intended for use on permanently installed above-ground swimming pools and may also be used with hot tubs and spas if so marked. Do NOT use with storable pools. A permanently installed pool is constructed in or on the ground or in a building such that it cannot be readily disassembled for storage. A storable pool is constructed so that it is capable of being readily disassembled for storage and reassembled to its original integrity.

Model No.		CC1000	CC1500
Effective Filtration Area		100 FT ²	150 FT ²
Design Flow Rate		80 GPM	100 GPM
Maximum Working Pressure		30 PSI	30 PSI
Required Clearance:			
Side		18"	18"
Above		24"	30"
Replacement Hayward Cartridge		CCX1000RE	CCX1500RE
Turnover	8 Hours	38,400 GAL	48,000 GAL
	12 Hours	57,600 GAL	72,000 GAL

General Information

Introduction

This manual contains information for the proper installation and operation of the Hayward® XStream™ Filtration Series. All XStream™ Filtration models are high performance, above-ground swimming pool filters. Instructions in this manual **MUST** be followed precisely.

Product Features

- Engineered for easy use with flexible or rigid plumbing.
- Sleek, flush mounted pressure gauge.
- Extra large dirt capacity.
- Quick release, high capacity air relief valve.
- Glass reinforced, non-corrosive filter tank will provide years of trouble-free operation.
- Easy-Lok™ ring design allows quick access to all internal components in a single turn.

Installation Instructions

Filter Location

This product is designed for outdoor use. It is strongly advised to protect the electrical components from the weather. Set the filter on firm, level ground. Select a well-drained area, one that will not flood when it rains. Position the filter so that it may drain by gravity. It requires free circulation of air for cooling. Do not install in a damp or non-ventilated location. The tank should be positioned for easy access to the internals, pressure gauge, and air relief valve.

Plumbing

To facilitate servicing of the filter system and to allow for indoor storage during the winter months, installing union connections at the suction and outlet ports is recommended.

Use **TFE** to seal threaded connections on molded plastic components. All plastic fittings must be new or thoroughly cleaned before use. **NOTE: Do NOT use Plumber's Pipe Dope as it may cause cracking of the plastic components.** When applying **TFE tape** to plastic threads, wrap the entire threaded portion of the male fitting with one to two layers of tape. Wind the tape clockwise as you face the open end of the fitting, beginning at the end of the fitting.

The pump suction and outlet ports have molded-in thread stops. Do **NOT** attempt to force hose connector fitting past this stop. It is only necessary to tighten fittings enough to prevent leakage. Tighten fitting by hand and then use a tool to engage fitting an additional 1 ½ turns. Use care when using TFE tape as friction is reduced considerably; **do NOT over-tighten** fitting or you may cause damage. If leaks occur, remove connector, clean off old TFE tape, rewrap with one to two additional layers of Teflon tape, and re-install connector. Use 1 ½" I.D. flexible plastic pipe with hose adapter fittings and hose clamps. If rigid PVC is used, be sure to install Hayward SP1500UNPAK2 union connectors for easy servicing.

All plumbing connections on the XStream™ Filter are 1 ½" N.P.T. When making connections, use plastic male-end adapters. Apply three (3) turns of TFE tape or plastic pipe sealant to the male threads. Screw the fitting into the thread hand-tight; then using a wrench, tighten one more full turn, if necessary. (NOTE: Adapters have varying tolerances and over-tightening with a wrench may only cause damage to the filter.) Ball type valves are recommended where needed.

Connect the pool suction plumbing between the skimmer and the pump. Connect the pool return plumbing to the **OUTLET** port at the bottom of the filter body.

A filter drain or plug is furnished with each filter and is all that is needed for complete filter draining. A manual air relief valve is furnished to aid in the bleeding of unwanted air when starting or draining the filter.

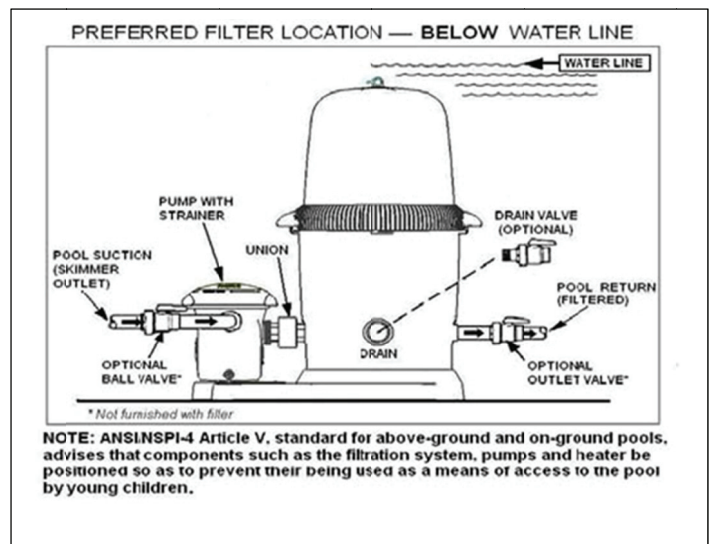

Start-Up & Operation

New Installation/Seasonal Start-Up

1. Close drain valve at the base of filter.
2. Secure and lock Easy-Lok™ ring.
 - ▲ **WARNING COMPONENT SEPARATION HAZARD**
Failure to properly secure the filter head could cause severe personal injury and/or property damage. To prevent component separation always turn Easy-Lok ring until it is fully latched into body.
3. Open air relief valve (Turn lever to left).
4. Open valves (Optional suction & return valves).



- ▲ **WARNING COMPONENT SEPARATION HAZARD**
Failure to open all suction and outlet valves before operating the filter system could cause severe personal injury and/or property damage. To prevent component separation open all suction and outlet valves before operating the filter system.

5. Prime and start the pump per manufacturer's instructions.
6. Once air has escaped the filter and a steady stream of water is flowing from the air relief valve, close the air relief valve and note the pressure gauge reading.



Filter Disassembly & Assembly

Cleaning/Removing Cartridge Element

NOTICE: An indication that the filter needs cleaning is when the pressure gauge rises 5-7 PSI above its normal pressure.

1. Shut off the pump.
2. Close valves* (*optional: suction & return valves).
3. Open air relief valve.
4. Open drain plug (located at the base of the filter body).
5. Depress safety latches (located on the underside of the locking ring handles) and unscrew locking ring in a counter-clockwise direction. Remove lid from filter body.
6. Lift out filter element and clean as instructed in “Preventative Maintenance” section of this manual.

Re-Installing Cartridge Element

1. Clean debris from bottom of filter tank.
2. Replace element evenly on the collector hub in bottom of the filter body.
3. Place lid evenly on filter body and turn Easy-Lok™ ring clockwise until the safety latches engage securely.
4. Close and secure drain plug (located at the base of filter body).
5. Proceed as in “Start-Up & Operation”

Preventative Maintenance

Cleaning Cartridge Filter

NOTICE: Clean the cartridge when filter canister pressure reaches 5-7 PSI above the initial system or new cartridge starting pressure.

1. Remove the cartridge element from the filter housing following the directions in the “Cleaning/Removing Cartridge Element” section above.
2. **DO NOT** Pressure wash. Wash the cartridge element inside and out with the Hayward Jet-action Cleaning Wand (EC2024) or a garden hose. Work from top-down, holding the nozzle at a 45-degree angle. All dirt and debris may not be removed with hosing. Brush pleated surface areas and allow to dry.

Vacuumping

Vacuumping can be performed directly into the filter whenever needed. For fastest results, clean the filter before and after each vacuumping. For heavy spring clean ups, we recommend using a Hayward SP0727 diverter valve to bypass the filter and accelerate the clean up process. Consult your local Hayward dealer for a detailed explanation.

Winterization

In areas where sub-freezing temperatures can be expected, the filter should be drained and/or removed from its operating location and stored indoors. Clean the cartridge element at the end of the pool season by using the Hayward Jet-action Cleaning Wand (EC2024) or a garden hose. (See “Cleaning Cartridge Filter” instructions in this manual).

TROUBLE SHOOTING		
Problem	What to Look For	Treatment
Dirty, clogged, or abused element	Dirt, debris, or tear in pleats or folds	Clean or replace element
Oversized pump - Produces excessive flow rates and/or pressures	Flattened pleats or folds; Embedded dirt or debris into the filter material; Breaking of internal core of the element; Breaking or splitting of the end plates of the element	Re-size pump
Very dirty pool water	Algae buildup on the pool walls	Frequent cartridge cleaning or replacement; Consult professional pool company for pool chemistry instructions.

REPLACEMENT PARTS			
REF NO	Part No.	Description	No. Req
1	ECX27091	Pressure Gauge	1
2	CCX1000I	Threaded Adaptor	1
3	CCX1000V	Air Relief Assy	1
4	CCX1000D	Lock Ring Assy	1
5	CCX1000H	Lock Ring Latch	2
6a	CCX1000C	100 Filter Lid w/ Lock Ring	1
6b	CCX1500C	150 Filter Lid w/ Lock Ring	1
7	CCX1000N	Adapter Nut	2
8a	CCX1000RE	Cartridge Element	1
8b	CCX1500RE	Cartridge Element	1
9	CCX1000B	Filter, Lower Body	1
10	SP1480BLK	Self Aligning Union (Black)	1
11		Pump	1
12	CCX1000A	Base, Standard	1
13	SP1022CBLK	Drain Plug w/O-ring	1
14	CCX1000G	O-ring, Body	1
15	SPX1500W	O-ring	1
16	CCX1000Z5	O-Ring set	1
17	SP1500UNP AK1	Union Connector (Optional)	1
18	SP1484	Self-Aligning Union, (Optional)	1

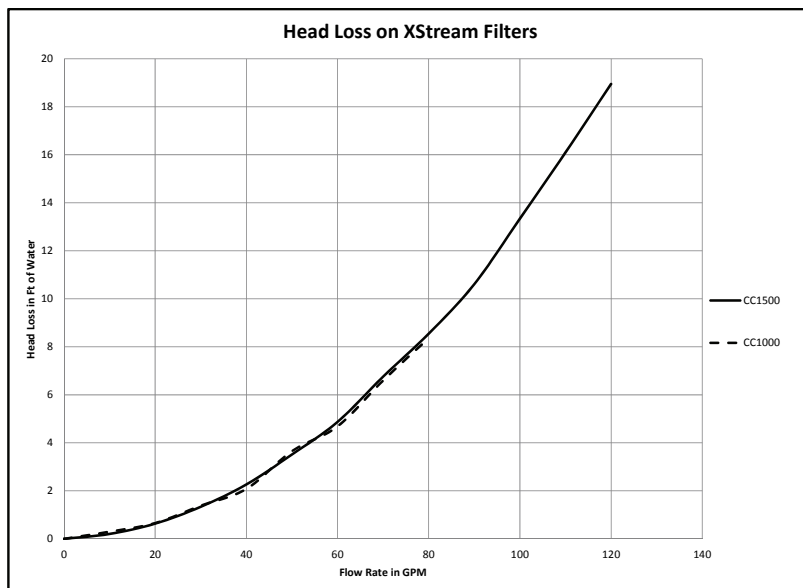
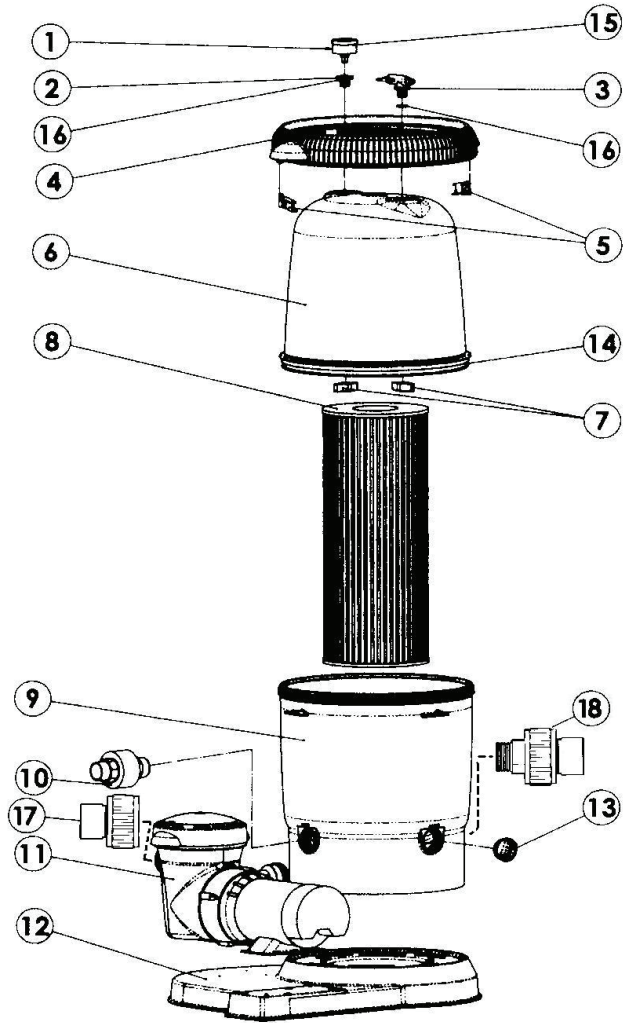



HAYWARD®

PRODUCT REGISTRATION

(Retain For Your Records)

DATE OF INSTALLATION _____

▲ Retain this Warranty Certificate (upper portion) in a safe and convenient location for your records.

HAYWARD® Pool Products Limited Warranty

To original purchasers of this equipment, Hayward Pool Products, Inc. warrants its products to be free from defects in materials and workmanship for a period of ONE (1) year from the date of purchase, when used in single family residential applications.

The limited warranty excludes damage from freezing, negligence, improper installation, improper use or care or any Acts of God. Parts that fail or become defective during the warranty period shall be repaired or replaced, at our option, within 90 days of the receipt of defective product, barring unforeseen delays, without charge.

Proof of purchase is required for warranty service. In the event proof of purchase is not available, the manufacturing date of the product will be the sole determination of the purchase date.

To obtain warranty service, please contact the place of purchase or the nearest Hayward Authorized Service Center. For assistance on your nearest Hayward Authorized Service Center please visit us at www.hayward.com.

Hayward shall not be responsible for cartage, removal, repair or installation labor or any other such costs incurred in obtaining warranty replacements or repair.

The Hayward Pool products warranty does not apply to components manufactured by others. For such products, the warranty established by the respective manufacturer will apply.

The express limited warranty above constitutes the entire warranty of Hayward Pool Products with respect to its' pool products and is in lieu of all other warranties expressed or implied, including warranties of merchantability or fitness for a particular purpose. In no event shall Hayward Pool products be responsible for any consequential, special or incidental damages of any nature.

Some states do not allow a limitation on how long an implied warranty lasts, or the exclusion of incidental or consequential damages, so the above limitation may not apply to you. This warranty gives you specific legal rights, and you may also have other rights, which vary from state to state.

Hayward Pool Products
620 Division Street
Elizabeth, NJ 07207

*Supersedes all previous publications.



DETACH HERE: Fill out bottom portion completely and mail within 10 days of purchase/installation or register online.

XStream™ Cartridge Filter

Warranty Card Registration

Register online at www.hayward.com

Please Print Clearly:

First Name _____ Last Name _____

Street Address _____

City _____ State _____ Zip _____

Phone Number _____ Purchase Date _____

E-Mail Address _____

Serial Number _____

Model Number _____

Pool Capacity _____ (U.S. Gallons)

If your product contains components that have individual serial numbers, it is not necessary to complete warranty registration for those individual components. Instead, complete warranty registration only for the overall product, using the serial number that is located on the outside of the product packaging.

Please include me on all e-mail communications regarding Hayward® Equipment or promotions.

Mail to: Hayward Pool Products, 620 Division Street, Elizabeth, NJ 07207

Attn: Warranty Dept

Or REGISTER YOUR WARRANTY ON-LINE AT WWW.HAYWARD.COM

Years Pool has been in service	
< 1 year	1-3 4-5 6-10 11-15 >15
Purchased from _____	
Builder	Retailer Pool Service Internet/Catalog
Company Name _____	
Address _____	
City _____	State _____ Zip _____
Phone _____	
Type of Pool:	
Concrete/Gunite	Vinyl Fiberglass
Other _____	
New Installation	
Replacement	
Installation for:	
In Ground	Above Ground Spa



Hayward is a registered trademark and XStream is a trademark of Hayward Industries, Inc.
© 2015 Hayward Industries, Inc.