

# INSTALLATION AND OPERATION MANUAL



## Heat Pump Pool & Spa Heater

Models: TWPH 4550, 5550, 6550,  
6550EHC, 8550, & 8550EHC



### NOTICE

SCAN WITH QR EQUIPPED SMART  
DEVICE FOR ONLINE MANUAL.



**FOR YOUR SAFETY:** Do not store or use gasoline or other flammable vapors and liquids or other combustible materials in the vicinity of this or any other appliance. To do so may result in an explosion or fire.

**NOTE:** The instructions in this manual are for the use of qualified individuals specially trained and experienced in the installation and maintenance of this type of equipment and related system components. Installation and service personnel are required by some states to be licensed. Persons not qualified shall not attempt to install, service, or maintain this equipment.

This manual should be maintained in legible condition and kept adjacent to the heat pump pool heater or in a safe place for future use.



Effective: 11-30-2023  
Replaces: 08-06-2023  
P/N: 100-10000496 Rev. 03

# QUICK START GUIDE

---

## CLEARANCES

- Installation Considerations Page 6.
- Installation Clearances Page 7.
- Hurricane Tie Down Instructions Page 8.

## PIPING

- Water Connections Page 9.
- Flow Rate & Pressure Drop Page 9.
- Freeze Protection Page 34.
- Plumbing Diagrams Page 38.

## WATER CHEMISTRY

- Water Chemistry Page 6.
- Table A. Water Chemistry Page 6.

## POWER

- Electrical Connections Page 10.
- Table C. Typical System Electrical Power Requirements Page 10.

## CONTROLS INTERFACE

- Wiring Diagram -  
208V/230V Single-Phase Page 11.
- Heater Control Display Page 12.
- Program Menu Page 17.
- Digital Controls Operation Page 27.
- Remote Mode Selector Page 31.
- Connect to Wi-Fi with Raymote Page 44.
- External Control Outputs Page 72.

### Revision 03 reflects the following changes:

Removed "For Heat Only models, a check valve is provided in the packaging: from "NOTE" in Section 2. Added Water Flow Switch section to Installation Consideration section. Added new Figure 4. Added anchoring details (A through D) to Figure 5. Listed "Water Flow Switch" (WFS) to Figure 8. Removed "External Bypass Required" from Note on Figure 64. Added Figure 65 (Water Flow Switch installation). Added "Water Flow Switch Wiring" to External Control Output section . Added item "6-M" to the Illustrated Parts List.

# TABLE OF CONTENTS

<b>1. WARNINGS</b> .....	<b>4</b>	<b>16. REMOTE MODE SELECTOR</b> .....	<b>31</b>
Pay Attention to these Terms .....	4	<b>17. SEASONAL START-UP OR</b>	
<b>2. INTRODUCTION</b> .....	<b>5</b>	<b>ANNUAL CHECK</b> .....	<b>34</b>
<b>3. WATER CHEMISTRY</b> .....	<b>6</b>	<b>18. SUMMER SHUTDOWN</b> .....	<b>34</b>
<b>4. INSTALLATION CONSIDERATIONS</b> .....	<b>6</b>	<b>19. FREEZE PROTECTION</b> .....	<b>34</b>
<b>5. WATER CONNECTIONS</b> .....	<b>9</b>	System Drain-Down .....	34
<b>6. FLOW RATE &amp; PRESSURE DROP</b> .....	<b>9</b>	Continuous Pump Operation.....	34
<b>7. ELECTRICAL CONNECTIONS</b> .....	<b>9</b>	<b>20. MAINTENANCE</b> .....	<b>34</b>
<b>8. WIRING DIAGRAM</b> .....	<b>11</b>	Air Coil Cleaning .....	35
<b>9. HEATER CONTROL DISPLAY</b> .....	<b>12</b>	Cabinet Care (optional).....	35
<b>10. OPERATION MODES</b> .....	<b>12</b>	Unplug Condensation Drain Holes.....	35
<b>11. SERVICE MENU</b> .....	<b>14</b>	<b>21. TROUBLESHOOTING</b> .....	<b>35</b>
Operations and Service Menu.....	16	<b>22. SERVICE CALL VERIFICATION</b> .....	<b>36</b>
<b>12. PROGRAM MENU</b> .....	<b>21</b>	Power Supply .....	36
Program Menu Diagram.....	20	Water Flow .....	36
<b>13. INSTALLER MENU</b> .....	<b>21</b>	Time Clock Adjustment .....	36
Installer Menu Diagram .....	24	Set Factory Defaults.....	36
<b>14. SCHEDULE MENU</b> .....	<b>25</b>	Service Access to Heaters .....	37
Schedule Menu Diagram.....	26	<b>23. PLUMBING DIAGRAMS</b> .....	<b>38</b>
<b>15. DIGITAL CONTROLS OPERATION</b> .....	<b>27</b>	<b>24. RESISTANCE SENSOR VALUES</b> .....	<b>43</b>
Sequence of Operation .....	27	<b>25. CONNECT TO WI-FI WITH RAYMOTE</b> .....	<b>44</b>
System Start-Up.....	27	<b>26. RAYMOTE MOBILE APP</b> .....	<b>49</b>
Operational Status Messages .....	28	<b>27. EXTERNAL CONTROL OUTPUTS</b> .....	<b>72</b>
Error Messages.....	29	<b>28. REPLACEMENT PARTS</b> .....	<b>86</b>
		<b>29. ILLUSTRATED PARTS LIST</b> .....	<b>87</b>

# 1. WARNINGS

## Pay Attention to these Terms

<b>▲ DANGER</b>	Indicates the presence of immediate hazards which will cause severe personal injury, death or substantial property damage if ignored.
<b>▲ WARNING</b>	Indicates the presence of hazards or unsafe practices which could cause severe personal injury, death or substantial property damage if ignored.
<b>▲ CAUTION</b>	Indicates the presence of hazards or unsafe practices which could cause minor personal injury or product or property damage if ignored.
<b>CAUTION</b>	CAUTION used without the warning alert symbol indicates a potentially hazardous condition which could cause minor personal injury or product or property damage if ignored.
<b>NOTE</b>	Indicates special instructions on installation, operation, or maintenance which are important but not related to personal injury hazards.

This manual, as well as the pool heater itself, contains ANSI-approved product safety signs and labels. Please read these signs and labels, as they convey important safety information about hazards that may be potentially present in and around the heater.

**▲ CAUTION:** Elevated water temperature can be hazardous. The U.S. Consumer Product Safety Commission has these guidelines:

1. Spa water temperatures should never exceed 104°F (40°C). A temperature of 100°F (38°C) is considered safe for a healthy adult. Special caution is suggested for young children.
2. Drinking of alcoholic beverages before or during spa or hot tub use can cause drowsiness which could lead to unconsciousness and subsequently result in drowning.
3. Pregnant Women Beware! Soaking in water over 102°F (39°C) can cause fetal damage during the first three months of pregnancy resulting in the birth of a brain-damaged or deformed child. Pregnant women should stick to the 100°F (38°C) maximum rule.
4. Before entering the spa or hot tub, users should check the water temperature with an accurate thermometer; spa or hot tub thermostats may err in regulating water temperatures by as much as 4°F (2.2°C).
5. Persons with a medical history of heart disease, circulatory problems, diabetes, or blood pressure problems should obtain a physician's advice before using pools or hot tubs.
6. Persons taking medications which induce drowsiness, such as tranquilizers, antihistamines, or anticoagulants, should not use spas or hot tubs.

**CAUTION:** Improper chemical content in a swimming pool or spa can damage the heater. **DO NOT** add pool/spa chemicals to the pool/spa via the skimmer or any other apparatus (feeder, chlorinator, etc.), that is on the influent side (i.e. before) of the heater. This will damage the heater and could void the heater warranty. **ALWAYS** follow the product manufacturer's directions when adding any chemicals to your pool.

**▲ WARNING:** These heat pump pool heaters are charged with R-410A refrigerant. Ensure that all service work is done with gauges and equipment suitable for R-410A.

**EFFICIENCY TESTING NOTICE:** For purposes of verifying or testing efficiency ratings, the test procedure in Title 10 APPENDIX P to Subpart B of Part 430 (Uniform Test Method for Measuring the Energy Consumption of Pool Heaters) and the clarifying provisions provided in the AHRI Operations Manual 1160 that were applicable at the date of manufacture should be used for test set up and performance. Charging Chart are available at <https://www.raypak.com/customer-support/heat-pump-charging-charts>. These should only be used by certified HVAC technicians to check or adjust refrigerant charge for proper operation.

**CAUTION:** The appliance is not to be used by persons (including children) with reduced physical, sensory or mental capabilities, or lack of experience and knowledge, unless they have been given supervision or instruction. Do not allow children to play near or with appliance, severe damage can occur from moving parts.

## 2. INTRODUCTION

**⚠ WARNING:** This heat pump pool heater is an electromechanical machine that incorporates a pressurized refrigerant gas in a sealed system. **ONLY trained and qualified service personnel are authorized to install or service this equipment. Without proper training and knowledge of such equipment, any attempt to install or service the unit could result in serious injury or even death.**

This manual contains important information on the use, maintenance and troubleshooting of your new heat pump pool heater. This unit must be properly installed, maintained and operated for optimal performance.

This heater is an extremely efficient, economical machine designed specifically for heating swimming pools. It is similar in design and operation to a typical residential air conditioning system. The unit employs a hermetic motor/compressor operating in a refrigeration cycle to extract heat from ambient air and deliver it to the circulating pool water.

All heat pump pool heaters have a lower BTU/hr heating capacity than a gas-fired or oil-fired heater for the same pool and will have to operate more hours per day to keep the pool at setpoint. It may operate up to 24-hours a day at certain times. It is designed to do so. Even with long runtime hours, it will heat the pool at less cost than other heaters using fossil fuel.

Since evaporation is the main cause of heat loss from a pool, keeping the pool covered whenever it is not in use will greatly reduce the cost of keeping the pool heated. Even during warmer weather, Raypak recommends keeping the pool covered at night.

**NOTE:** 4x Hurricane tie-down brackets, 16x tie-down screws, 2x union halves, the printed warranty, optional harnesses and the I&O manual are located in an accessory bag mounted on the front of the heater inside the packaging. For Heat/Cool models, a bypass assembly is provided. Please **DO NOT** throw away the packaging before removing all of their contents.

### ATTENTION: Please Take This Opportunity to Quickly Register Your Unit!!

While your unit is being installed by your professional and licensed installer of choice, Please Take This Opportunity to Quickly Register Your Unit!! With the necessary information in hand, Registering your new Heat Pump Pool Heater only takes a few moments and is the only way to assure any verifiable warranty procedures during the span of your unit's period of protection.

Using Figure 1, please locate and record your model and serial number. Once you have done this, please make sure you also have the following information on hand:

- Name, phone number, and email address of homeowner
- Physical address of where the unit is installed; please include any 'subdivision' or similar information

- Any service challenges present at the house/neighborhood: gated community, locked access at house, guard dog, etc.
- Date of installation of the new unit
- Name and phone number of the professional and licensed entity that performed the installation for you

With all of the above information in hand, please contact Raypak and ask to register your brand new heat pump or Online at:

[https://www.raypak.com/support/registration\\_warranty/](https://www.raypak.com/support/registration_warranty/)

You will be given a Warranty Registration Confirmation number which you should notate and keep in one location along with your Installation & Owner's Manual, a copy of your warranty (provided with your manual) and the above information.

This unit is equipped with a QR Code on the rating plate, as shown in Figure 1, which will take you to the [www.raypak.com](http://www.raypak.com) website where the Installation & Owner's manual and other documents can be easily accessed.

This would also be a good time to review both the manual and the warranty so that you are aware of how to correctly operate your new equipment as well as how to keep from voiding any aspects of your warranty. During the life of your unit, please feel free to use the phone number conveniently located right on the unit, to contact us with any questions you may have about operation, warranty, and/or service.

Thank you very much choosing Raypak to satisfy your pool heating needs!!

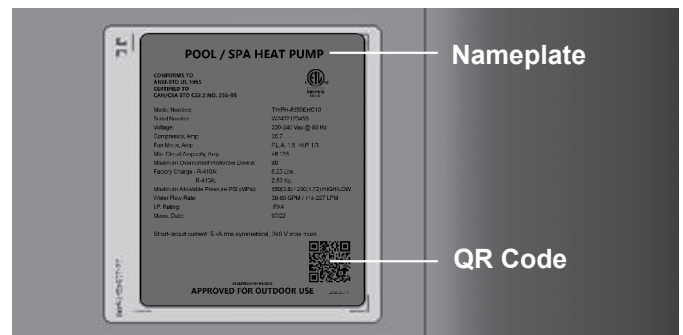

Figure 1. Model and Serial Number Location  
Warranty Registration Confirmation #:



Scan this QR with your smart device to register or verify your new Raypak heater.

### 3. WATER CHEMISTRY

#### IMPORTANT: Corrosive water voids all warranties.

For your health and the protection of your pool equipment, it is essential that your water be chemically balanced. The following levels in Table A must be used as a guide for balanced water.

- Occasional chemical shock dosing of the pool or spa water should not damage the heater providing the water is balanced. However, it is highly recommended that the heat pump pool heater is isolated via shut off valves before any aggressive chemical treatment.
- Automatic chemical dosing devices and salt chlorinators are usually more efficient in heated water. Unless controlled, they can lead to excessive chlorine level which can damage your heater.
- Further advice should be obtained from your pool or spa builder, accredited pool shop, or chemical supplier for the correct levels for your water.

Situate the heater carefully to minimize installation costs while providing maximum efficiency of operation, and to allow adequate service access, as follows:

- For unrestricted air intake and service access, position each side of the unit at least 1 ft (30 cm) from walls, pipes and other obstructions.

**⚠ WARNING:** This unit is designed for outdoor installation. It is NOT certified for indoor installation. DO NOT install it in an enclosed area such as a shed or garage, or under a porch or deck.

- This unit features an ‘up-flow’ discharge for quiet operation. Air is pulled up through the evaporator coil and discharged through the top grill. Allow at least 5 ft (1.5 m) clearance above the unit for unrestricted air discharge. Do NOT install the unit under a porch or deck. Refer to Figure 2 for installation clearances. Allowing cold discharge air to recirculate back into the evaporator coil will greatly reduce the unit’s heating capacity and efficiency. To minimize water piping, locate the unit as close as possible to the existing pool pump and filter.
- Irrigation water should be directed away from the heat pump pool heater - irrigation water spray can damage the heater.
- Rain water runoffs - the unit is designed to operate outdoors and can be exposed to rain. However, rain water runoff falling directly onto the unit can cause damage and/or shorten the life of your unit. Such damage is NOT covered under warranty. Install rain gutters or rain diverters on your roof if the unit is installed in a position where contact with rain runoff may occur.
- It is important to keep the area next to the heater clear of shrubs, bushes and chemicals containers. They could prevent air from circulating fully through the heater, and will affect the operation of the heater or damage the heater.

### 4. INSTALLATION CONSIDERATIONS

**⚠ WARNING:** Do not install the unit within 3 ft (0.9 m) of fossil-fuel-burning heaters. Air intake along the sides of this heat pump pool heater could disturb the combustion process of the unit, and could cause damage or personal injury.

- Mount the unit on a level, sturdy base, preferably a concrete slab. The size of the base should be at least 3 ft by 3 ft (0.9 m x 0.9 m) - slightly larger if hurricane tie-down brackets are installed. See Figure 5 for more details.

**CAUTION:** The unit’s supporting base must be high enough to keep it completely free of standing water at all times.

Recommended Level(s)	Fiberglass Pools	Fiberglass Spas	Other Pool & Spa Types
Water Temp.	68 °F to 88 °F (20°C to 31°C)	89 °F to 104 °F (32°C to 40°C)	68 °F to 104 °F (20°C to 40°C)
pH	7.3 to 7.4	7.3 to 7.4	7.6 to 7.8
Total Alkalinity (PPM)	120 to 150	120 to 150	80 to 120
Calcium Hardness (PPM)	200 to 300	150 to 200	200 to 400
Salt (PPM)	4500 MAXIMUM	4500 MAXIMUM	4500 MAXIMUM
Free Chlorine (PPM)*	2 to 3	2 to 3	2 to 3
Total Dissolved Solids (PPM)	3000 MAXIMUM**	3000 MAXIMUM**	3000 MAXIMUM**
Water Pressure (psi/kPa)	5 MIN. - 70 MAX. (35 MIN. - 483 MAX.)	5 MIN. - 70 MAX. (35 MIN. - 483 MAX.)	5 MIN. - 70 MAX. (35 MIN. - 483 MAX.)

\*Free Chlorine MUST NOT EXCEED 5 PPM!

\*\* In salt water chlorinated pools, the total TDS can be as high as 6000 ppm.

Table A. Water Chemistry

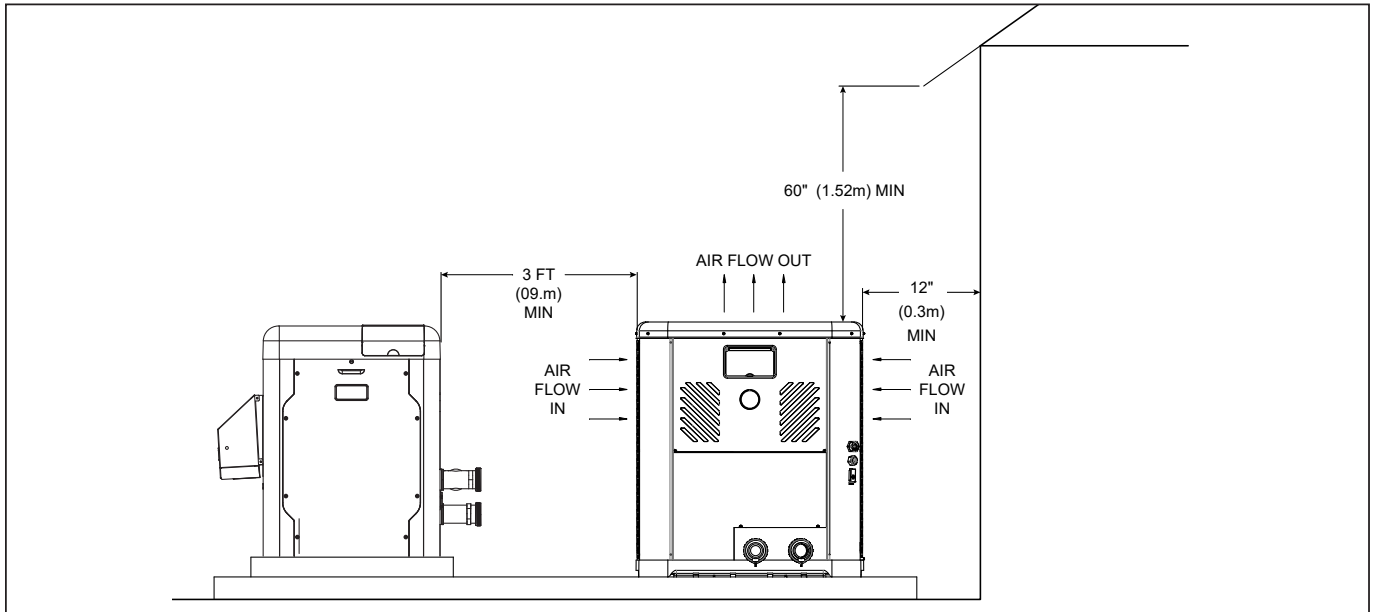

**Figure 2. Installation Clearances**

- When installed in areas where freezing temperatures can be encountered, drain the water circuit to prevent possible freeze-up damage. Refer to "Freeze Protection" on page 34 for proper procedures.
  - When the heater is located below the water line of the pool or spa, it may be necessary to adjust the Water Pressure Switch (WPS) to compensate for the no-flow static head (see Figure 4). If after adjusting the WPS to its maximum setting without resolution, an external Water Flow Switch (WFS) must be installed. See "Water Flow Switch" section below for further installation instructions.
  - For high-wind installation requirements, refer to Figure 5 – depending on the model size.
1. Install the WFS onto the water inlet piping as shown in Figure 65.
  2. The WFS must be installed before any bypass or check valve assembly.
  3. The WFS must be installed within a straight, horizontal piece of inlet piping of at least 5" in length. The WFS sensor is sized for 1.5" pipe, but can be converted to 2" if required.
  4. The WFS must be installed in close proximity to the heater. Raypak recommends to install no further than 2 ft. per Figure 65.
  5. Connect the WFS per the wiring instructions located on page 85.

**NOTE:** The base is designed with recessed areas to allow the use of hand trucks or lifting without the possibility of pinching fingers as shown in Figure 3.

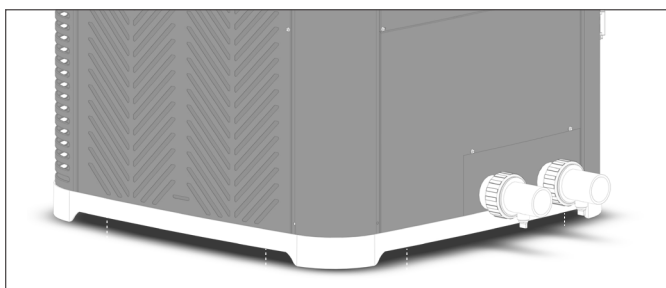

**Figure 3. Base Design - Handling**

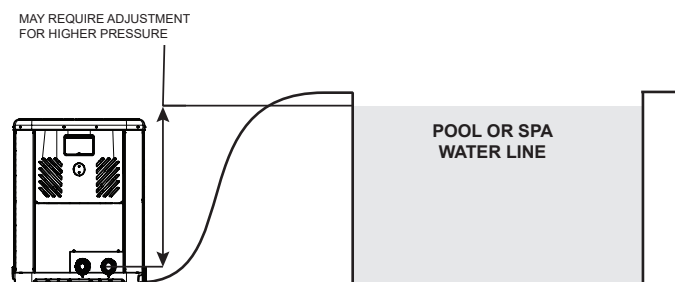

**Figure 4. Water Pressure Switch Adjustment**

## Water Flow Switch

If the heater is located below the water line of the pool, an external Water Flow Switch (WFS) must be installed. The WFS is provided with the heater and must be installed as per the following instructions to prevent nuisance heater tripping (for example: high-pressure switch fault) and to ensure proper operation.

Minimum pad dimensions are 43-1/4" x 4" thick.  
 Screws to attach brackets to unit are supplied with the unit.  
 DO NOT use screws not specified or provided by manufacturer. Screws are stainless steel #10 x 3/4" self-drilling. Each bracket requires 4 screws attached to the unit.

Miami Tech Clip: (0.07") ASTM A653  
 Fu=90 KSI Steel (CUTD10) or 0.080" 5052-H32 Aluminum (CUTDA10). Florida approval FL# 19731.1 or approved equal.

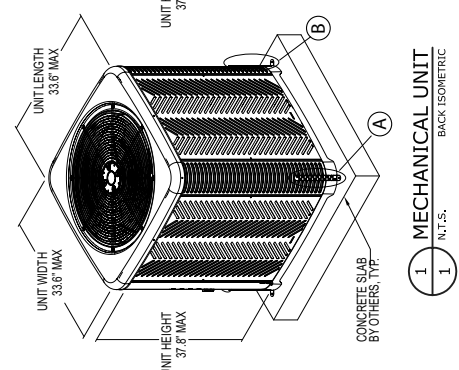
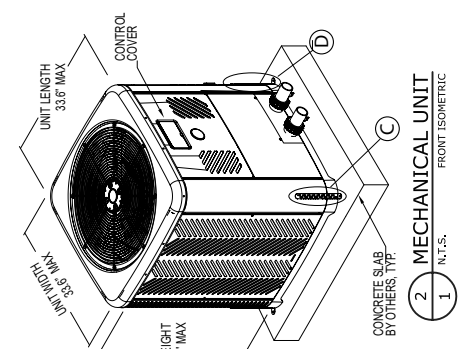
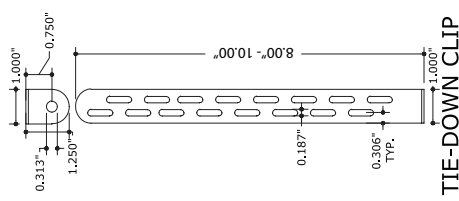

THESE ISOMETRICS ARE INTENDED FOR DIAGRAMMATICAL PURPOSES ONLY.

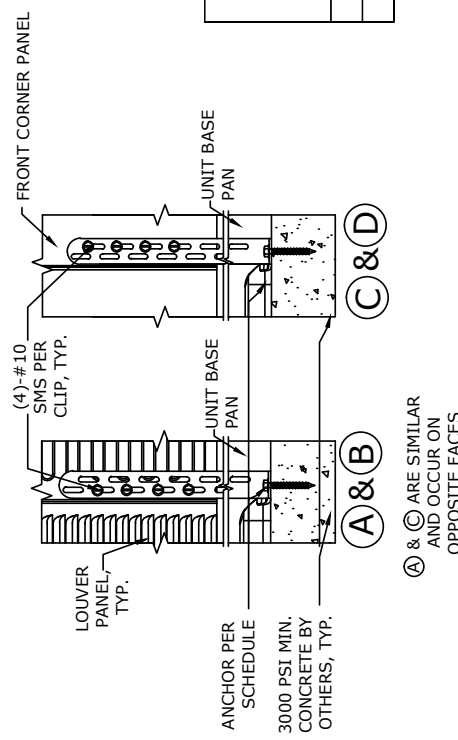

A & C ARE SIMILAR AND OCCUR ON OPPOSITE FACES

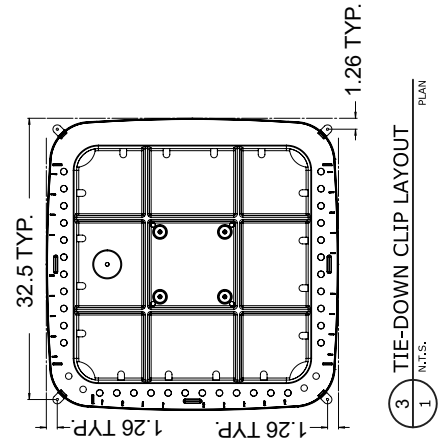

TIE-DOWN SCHEDULE

Installation Condition	Max. ASD Wind Pressures Lateral (Uplift)	# of Tie-Down Clips
At-Grade	± 54 psf (0 psf)	4
At-Grade / Rooftop	± 140 psf (111 psf)	8

**Maximum Rated Wind Pressures:  
 ± 140 psf Lateral, 111 psf Uplift**

Hurricane tie-downs are a structural component designed to prevent wind uplift during severe weather, such as hurricanes or severe storms. For further information on tie-downs, and technical support, contact Raypak at [www.raypak.com](http://www.raypak.com) or call 805-278-5300.

Figure 5. Hurricane Tie Down Instructions – Models: TWPH 4550, 5550, 6550, 6550EHC, 8550, & 8550EHC



## 5. WATER CONNECTIONS

**CAUTION:** The heater inlet and outlet are **NOT** interchangeable. They must be connected as instructed below.

**WARNING:** Improper installation of any type of automatic chemical feeders can result in serious damage to, or premature failure of, the heater and such damage will not be covered under warranty. Install a check valve and/or a Hartford loop **AFTER** the heater and **BEFORE** any chlorinating devices. Install any automatic chemical feeders **AFTER** the heater.

1. Connect the heater in the return water line between the filter and the pool/spa. See plumbing diagrams on page 38 (without bypass) and page 39 (with bypass).
2. Connect the filter outlet to the fitting marked **INLET** at the bottom front of the unit.
3. Connect the fitting marked **OUTLET** to the return piping to the pool/spa. Unit inlet/outlet connection fittings are 2-inch PVC unions on models 4550-8550.

Water connections from the unit to the main return line can be PVC pipe or flexible pipe approved for the purpose and, in either case, should be at least equal in size to the main pool/spa circulation piping.

- Water flow to the unit will exceed 40 GPM (151 LPM) for 4550 models or 50 GPM (189 LPM) for 5550-8550 models. See Figure 64 for bypass instructions.
- To protect (completely bypass) the unit from any harmful chemical treatments (i.e. Acid wash, back-to-back super chlorinators, stain treatments, etc.); or to be able to isolate the unit for service/repair or freeze preparation and still allow pool/spa circulation to continue.

In Heat/Cool models, a bypass assembly is included. Please refer to the plumbing on page 39, for further instruction.

Please note that some municipalities do not allow the use of a shutoff valve on the effluent/outlet side of any heating equipment, especially when there is one on the inlet side. These entities typically instead allow a PVC tee and spring check valve on the effluent/outlet side. This is allowed by Raypak and can also double as your protection from chemical feeders and chlorinators that are downstream of the unit.

4. Operate the pump and check the system for leaks.
5. Drain plugs are located on each union fitting as shown in Figure 6 for draining the system during winterizing.

**NOTE:** While it is possible to mount the upper union with the drain plug vertically, the manufacturer has determined that installing both unions with the drain plugs facing down, as shown in Figure 6, provides for the best draining of the system.

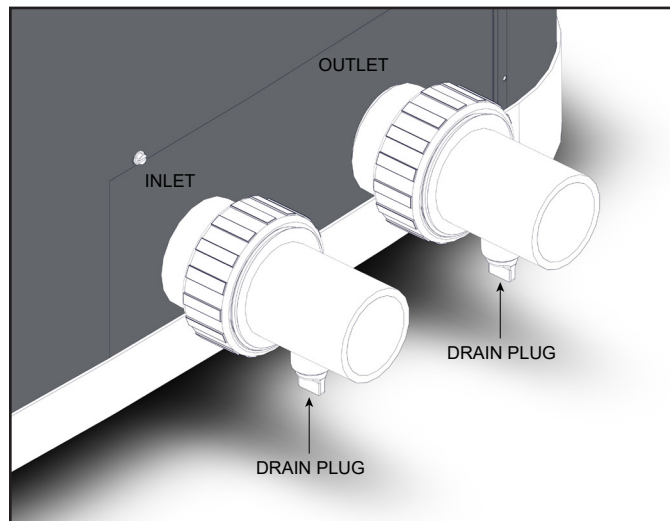

Figure 6. Water Connections/Drain Plugs

**CAUTION:** When the drain plugs are removed for draining the system, ensure that they are stored in a safe place for re-installation when needed to restart the system.

## 6. FLOW RATE & PRESSURE DROP

For system pressure drop information, see Table B.

Flow GPM (LPM)	Pressure Drop (PSI)			
	4550	5550	6550/ 6550EHC	8550/ 8550EHC
20 (750)	3.4			
30 (113)	7	4	6	9
40 (151)	13	7	9	9
50 (189)		10	10	10
60 (227)		11	11	11
70 (265)		12	12	12
80 (303)		13	13	13

Note: Minimum recommended flow is 20 GPM. Multiply the pressure drop in psi by 2.3067 to yield the pressure drop in Ft. H<sub>2</sub>O Head. (Total Dynamic Head TDH)

Table B. Flow Rate & Pressure Drop Across the Heater

# 7. ELECTRICAL CONNECTIONS

Refer to the unit rating plate below the control panel for precise power requirements for your unit, and for ampacity and over-current protection requirements.

All wiring must be in accordance with the National Electrical Code, NFPA No. 70, latest edition, and all applicable state and local codes. See wiring diagram on page 11.

**⚠ WARNING:** This unit **MUST** be installed using flexible conduit for supply wiring to the unit. This will allow movement of the conduit whenever the junction box is removed for service - see "Service Access to Heaters" on page 37.

- Locate the equipment disconnect means within 3 feet (0.9 m) of the heater's electrical enclosure, or as close to the heater as possible. Always satisfy applicable codes and standards.
- A means to fully disconnect the unit from the main power supply must be incorporated in the wiring of the unit.

**NOTE:** Refer to the National Electrical Code, Article 680, for general requirements for swimming pools and equipment, and to Article 440 for special considerations necessary for circuits supplying hermetic refrigeration motor/compressors.

- In sizing power wiring, be especially aware of up-sizing requirements necessary due to wiring distances. Always satisfy applicable codes and standards.
- Connect electrical Line 1 (L1) and Line 2 (L2) to the terminals indicated in Figure 7 for proper wiring. Electrical installation should be performed by a licensed electrician only.

This unit is compatible to work with external control systems, (optional harness provided in the packaging per **NOTE** on page 5) heat-on-demand options and other

external time clock overrides. Refer to the external control system's instructions, and "Remote Mode Selector", on page 31 of this manual, for installation information.

An earth ground lug is located to the right-side of the water connections.

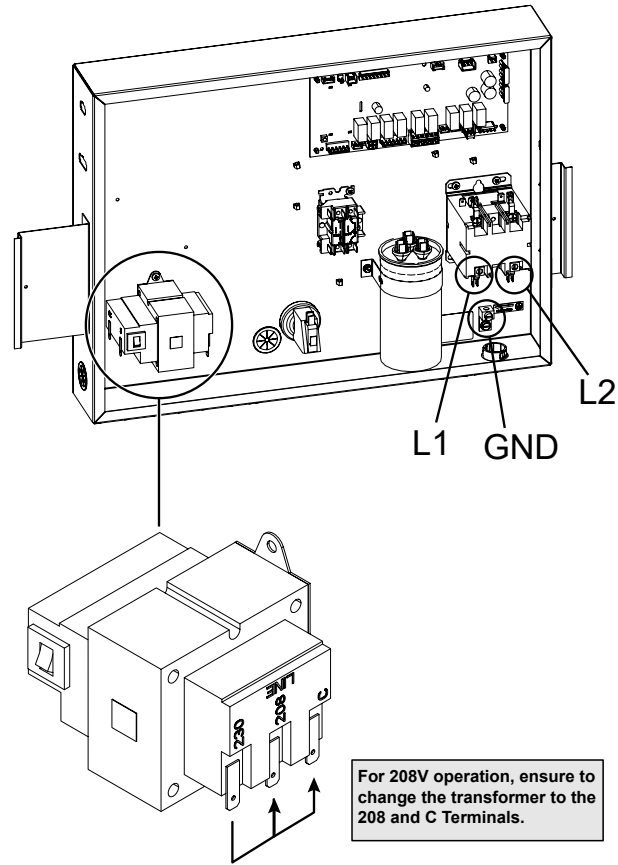

Figure 7. Terminals L1 and L2

Model No.	Power	Min. Circuit Ampacity	Breaker Size (AMP)	Recommended Wire Length from Breaker to Heater*, ft. (m)				
			MAX.	12 AWG	10 AWG	8 AWG	6 AWG	4 AWG
4550	208/230V - Single Phase - 60Hz	38	60	NR**	89 (27.1)	142 (43.3)	225 (68.6)	359 (109.4)
5550		40	70	NR**	94 (28.7)	151 (46.0)	239 (72.8)	383 (116.7)
6550		46	70	NR**	97 (29.6)	156 (47.5)	247 (75.3)	396 (120.7)
8550		46	70	NR**	NR**	110 (33.5)	175 (53.3)	280 (85.3)

\* Reference only - see National Electrical Code or local codes for wire gauge length limits.

\*\* NR= Not Recommended

Table C. Typical System Electrical Power Requirements

# 8. WIRING DIAGRAM

## 208V/230V Single-Phase – Heat only and Heat/Cool models

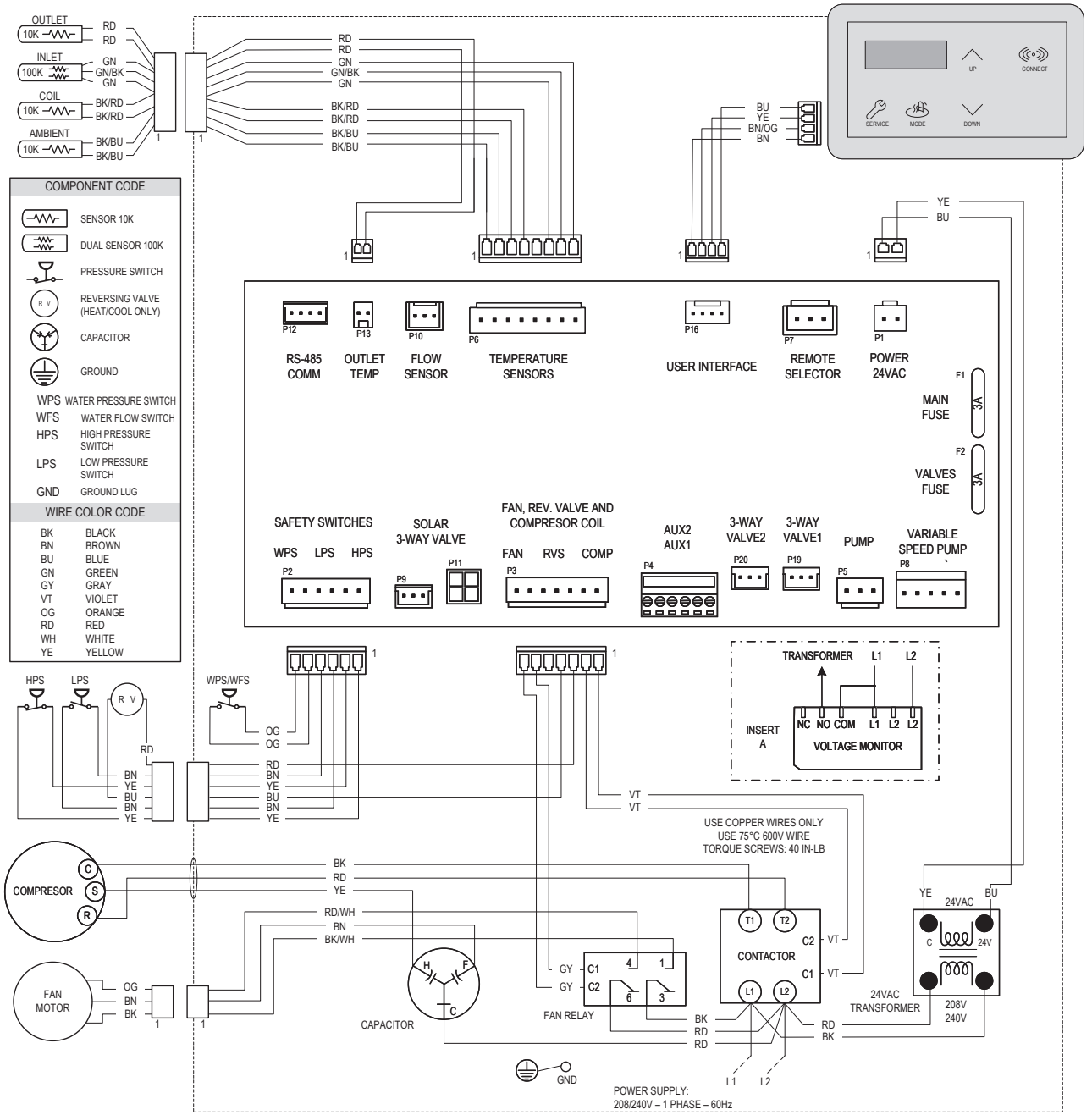

Figure 8. Heat Only and Heat/Cool Models Wiring Diagram

## 9. HEATER CONTROL DISPLAY

The heater display is located in the front panel of the heat pump, covered with a door. All operation and settings of the heater control are accomplished through the use of the five (5) touch keys of the user interface. These keys are displayed in Figure 9.

### Mode Key

The Mode Key is used to select one of several modes for pool or spa operation. It also allows the user to select the OFF mode of operation, during which the LCD, while displaying OFF, continues to show the water temperature. Refer to section 10, "Operation Modes" for details.

### UP and DOWN Keys

If the heater is in pool or spa mode, the desired water temperature (SETPPOINT), can be adjusted using the UP or DOWN keys.

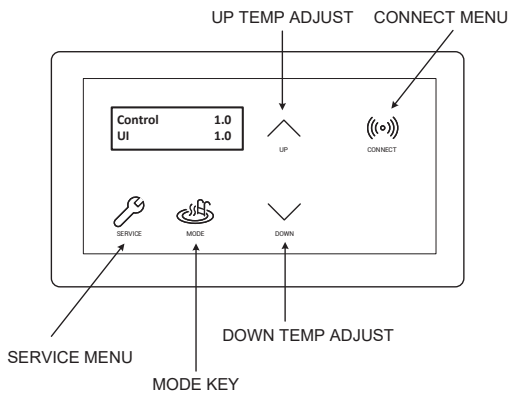

Figure 9. Heater Control Display

The display shows information on a 2-line, 16-character back-lit Liquid Crystal Display (LCD). The back-light is normally off, but it turns on for 5-minutes after power-up and for 5-minutes after any button press. Use the LCD to set up and monitor the operation of your heater.

If the control keys remains inactive for 5-minutes, the screen will revert to the current view.

On a normal power-up, the control displays the current software revision on the LCD for 2-seconds and then resumes the user-selected mode it was in before power was interrupted.

If unit type has not been set (like during the replacement of the control), the control prompts the user to set the model type (Heat Only or Heat/Cool) before any device operation is enabled.

Upon initial installation, there are several items that can be defined and programmed depending on the configuration and accessories intended to be controlled by the heater. Refer to "Program Menu" section on page 17 for details.

## 10. OPERATION MODES

The user may select one of several operating modes. Each mode is selected by pressing the MODE key to cycle between the modes. Each press of the MODE key selects the next mode.

On **Heat Only** models, the options available by pressing the MODE key are POOL, SPA, TIMED SPA and OFF.

On **Heat/Cool** models, the options available by pressing the MODE key are POOL COOL, POOL HEAT, POOL AUTO, SPA, TIMED SPA and OFF.

OFF	8:05P
Water Temp	68F

OFF	8:05P
No Demand	

Figure 10. Alternating Display

### Pool [Heat] and Spa Modes

The control is equipped with a Pool (heat) and Spa modes which will automatically heat the pool to the heating setpoint established in the selected mode.

The top row of the LCD displays the operation mode and temperature setpoint. When Pool (heat) or Spa mode is selected, each press of the UP or DOWN key will increase / decrease the water heating setpoint temperature. Holding the UP or DOWN keys down will speed up the change of the temperature values.

In these modes, the heater is set to heat when the water temperature is 1°F (0.5°C) degree below the selected temperature (setpoint). Heating is terminated when setpoint is reached.

When the water temperature is above the setpoint, the LCD will alternate "Water Temp" with "No Demand." When the water temperature is below the setpoint and the unit is heating, the LCD will alternate "Water Temp" with "Heating".

In POOL mode, default temperature setpoint is 80°F (27°C) with a maximum temperature limit of 95°F (35°C). In SPA mode, the default temperature setpoint is 100°F (38°C). with a maximum temperature limit of 104°F (40°C). Refer to "Program Menu", on page 18, to adjust pool or spa maximum temperature limits.

Pool set	85F
Water Temp	68F

Spa set	100F
Water Temp	68F

Pool set	85F
Heating	

Spa set	100F
Heating	

Figure 11. Pool Heat and Spa Modes

## Timed Spa Mode

The control is equipped with a mode which will heat the spa to the Spa setpoint temperature for a specified period of time selected in the TIMED SPA mode setup.

**⚠ WARNING:** If an external controller controls the spa heating in a pool/spa system, manual adjustment of the 3-way valves may be necessary to use the TIMED SPA feature of this heat pump. Failure to adjust the 3-way valves properly may result in pool water overheating or other undesirable results.

To activate the timed spa feature, press the MODE key until "TIMED SPA" is displayed on the top line of the display. The display will read "Up or Dn to Set". This tells the user to press the UP or DOWN keys to set the desired length of time for the timed spa heating operation.

Press the UP or DOWN keys to select the desired duration of spa heating, up to a maximum duration of 6-hours in 15-minute increments. After selection of time is completed press MODE key to start heater operation.

The timer will start to count down from the selected period and the unit will operate to heat the water based on the previously selected spa setpoint temperature setting.

Once the unit turns on, the display will toggle between the current spa water temperature and the current operating state "Heating" and the timer.

The top row of the LCD displays the operation mode and temperature setpoint. Timed Spa temperature setpoint can be adjusted using the UP and DOWN keys while the screen is displaying the Water Temperature and "Heating" status.

To adjust the timer, press MODE key, then use the UP and DOWN keys to increase or decrease the timer. To terminate the timer, use DOWN key to set timer to 00:00:00.

When the TIMED SPA timer has expired, the control will be set to OFF.

Timed Spa	100F
Up or Dn to Set	

Timed Spa	100F
Heating	2:30:00

Timed Spa	100F
Water Temp	68F

Figure 12. Timed Spa Mode

## Pool Cool Mode - Heat/Cool Models Only

In heat/cool models, the control is equipped with a "Pool Cool Mode" which will automatically cool the pool to the cooling setpoint established in this mode.

The top row of the LCD displays the operation mode and temperature setpoint. When pool cool mode is selected, each press of the UP or DOWN key will increase / decrease the water cooling setpoint temperature. Holding the UP or DOWN keys down will speed up the change of the temperature values.

In this mode, the heater is set to cool when the water temperature is 1°F (0.5°C) degree above the selected temperature (setpoint). Cooling is terminated when setpoint is reached.

When the water temperature is below the setpoint, the LCD will alternate "Water Temp" with "No Demand." When the water temperature is above the setpoint and the unit is cooling, the display will alternate "Water Temp" with "Cooling".

In pool cool mode, default temperature setpoint is 80°F (27°C) with a minimum temperature of 44°F (7°C) and maximum temperature limit of 95°F (35°C). Refer to "Program Menu", on page 18, to adjust pool maximum temperature limits.

Pool Cool	85F
Water Temp	95F

Pool Cool	85F
Cooling	

Figure 13. Pool Cool Mode

## Pool Auto Mode - Heat/Cool Models Only

The control is equipped with a mode which will automatically heat and cool the pool within the range of the heating setpoint and the cooling deadband.

The top row of the LCD displays the operation mode and temperature setpoint. When pool auto mode is selected, each press of the UP or DOWN key will increase / decrease the water setpoint temperature. Holding the UP or DOWN keys down will speed up the change of the temperature values.

In these modes, the heater is set to heat when the water temperature is 1°F (0.5°C) degree below the selected temperature (setpoint). Heating is terminated when setpoint is reached. The heater is set to cool when the water temperature is above the selected temperature (setpoint) plus the specified cooling deadband. Cooling is terminated when setpoint plus the cooling deadband is reached.

Example: When pool auto setpoint is set at 80°F (27°C) and cooling deadband set at 6°F (3.5°C), the unit will automatically heat the pool if the temperature drops below 80°F (27°C), and will automatically cool the pool if the temperature is above 86°F (30.5°C).

In pool auto mode, default temperature setpoint is 80°F (27°C) with a minimum temperature of 44°F (7°C) and maximum temperature limit of 95°F (35°C). Cooling deadband default is 6°F (3.5°C), adjustable from 2 to 10°F (1 to 5.5°C) degrees. Refer to "Program Menu", on page 18, to adjust pool maximum temperature limits and cooling deadband.

Pool Auto	85F	Pool Auto	85F
Water Temp	83F	Water Temp	92F
Pool Auto	85F	Pool Auto	85F
Heating		Cooling	

Figure 14. Pool Auto Mode

## Control Lockout Mode

Prevent unauthorized access to the heater's control settings with the "Control Lockout" feature. To activate the lockout, press and hold the MODE and DOWN keys simultaneously for 5-seconds. Select a three-digit PIN by using the UP and DOWN keys to select each digit and the MODE key to lock in the selection. Confirm your selection and make a record of your PIN for future reference.

Control Lockout	
Enter PIN	000
Confirm Lockout	
Yes	

Figure 15. Control Lockout

**NOTE: Record this lockout code for future reference.**

To unlock the controls, select the ENTER PIN menu by pressing the MODE key followed by the UP or DOWN key. Enter the three-digit PIN that was previously used to lock the control. Please note that power cycling will not clear the lockout. A successful PIN entry will display "LOCKBOX CLEARED," whereas an incorrect PIN will result in "INVALID PIN" being displayed.

If the user-selected PIN is lost or does not clear the Control Lockout, you can use the **Code 101** to temporary override the lock box and then the Program Menu to SET FACTORY DEFAULTS. This will remove the PIN and allow normal operation, including the selection of a new PIN if desired. Refer to the "Program Menu" section on page 16 for detailed instructions.

**NOTE: If you choose to set FACTORY DEFAULTS, the pool and spa setpoints will return to their default values of 85°F (29°C) and 100°F (38°C), respectively, and the maximum temperature settings for pool and spa will be reset to 95°F (35°C) and 104°F (40°C). It will be necessary to readjust these setpoints to your preferred settings. Additionally, other default configurations will be restored.**

## Keypad Protection

After 30-minutes of inactivity, the controller will automatically protect the keypad to avoid unintended key presses. Follow the on-screen instructions to unlock the keypad: Press the UP key three times, followed by the MODE key, to unlock.

## 11. SERVICE MENU

To access the "Service Menu" and fault history, press the SERVICE key 1-time. The heater will continue to operate while in the service menu.

In this mode, pressing the UP or DOWN keys will toggle through the various information reported. Some items ("Fault History" and "Sensor Temperatures") have multiple values. Press UP or DOWN buttons to scroll through the additional information. The SERVICE menu may be exited to return to the previous display by pressing the MODE key or it will automatically be exited if no key is pressed within 30-seconds.

## Supply Voltage

The first screen displayed is the "Supply Voltage" indicator, which indicates the voltage supplied to the control board. Normal readings range from 24 to 30 volts.

Supply Voltage	
	24V

Figure 16. Supply Voltage Indicator

## Run Time Hours and Cycles

Press the DOWN key. The "Hours" run time indicates the total hours of operation for the pool heater, as measured by the amount of time that the compressor has been energized. The "Cycles" count indicates the number of on/off cycles of the heater, as measured by the number of times the compressor has been energized.

Hours	451
Cycles	89

Figure 17. Run Time/Cycles

## Faults History

Press the DOWN key. The "Fault History" displays up to ten faults in memory. The order of the faults begins with "Last Err", which is the most recent fault, and proceeds through the ten most recent messages in reverse chronological order.

Run time hours at the moment of the fault are displayed at the end of the first line. The second line of the display shows the "Fault" message. If there are no faults in the history buffer, the second line reads "All Faults Clear."

Last Err	450
Inlet Temp Fail	

Fault 9	241
Brownout	

OR

Last Err	0
All Faults Clear	

Figure 18. Fault History

Press the Service  key again to access the Advance Service Menu.

## Heat Pump Temperatures

The "In/Out Temp" screen indicates the water temperature sensed in the inlet and at the outlet of the heater.

HPPH Temp	
In 68F, Out	78F

Figure 19. Inlet and Outlet Temperature

## Coil and Outdoor Temperature

Press the DOWN key. The "Coil Temp" screen indicates the temperature sensed, displayed on the first line. The second line displays the temperature sensed by the outdoor sensor.

Coil Temp	47F
Outdoor	68F

Figure 20. Coil and Outdoor Temperature

## Solar Heater Temperature (Heat/Cool Models Only)

Press the DOWN key. When enabled from "Installers Menu", the "Solar Temperature" screen indicates the temperature sensed with the solar heater sensor. The "In" reading indicates the inlet of the solar heater. Solar

inlet temperature readings should come from a field-supplied 10K temperature sensor. Solar "Out" displays the temperature at the outlet of the solar heater. This reading comes from the Heat pump inlet sensor. This screen is only displayed if the option "Solar Heating" is enabled from "Installers Menu". For more details about solar heater integration refer to section 13 Installers menu on page 21.

Solar Temp	
In 61F, Out	68F

Figure 21. Solar Heater Temperature

## Pump Status

Press the DOWN key. When enabled from "Installers Menu", the "Pump Status" screen indicates current pump mode and speed selection.

Pump control is compatible with Raypak Protégé Variable-speed Pump and 4 digital outputs speed selector. By default, "Pump Control" is disabled. See page 21 to select and configure "Pump Control" option.

Protégé Pump	
Speed2	1500 RPM

Pump Status	
	Speed 2

Figure 22. Pump Status

# Operations and Service Menu

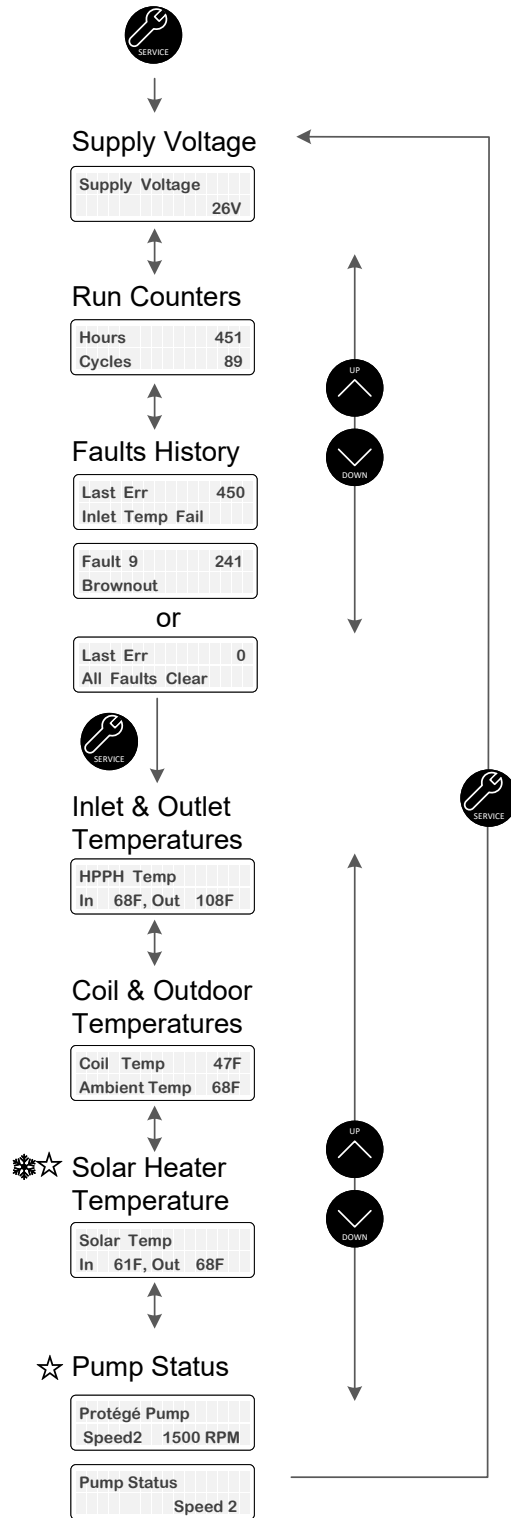
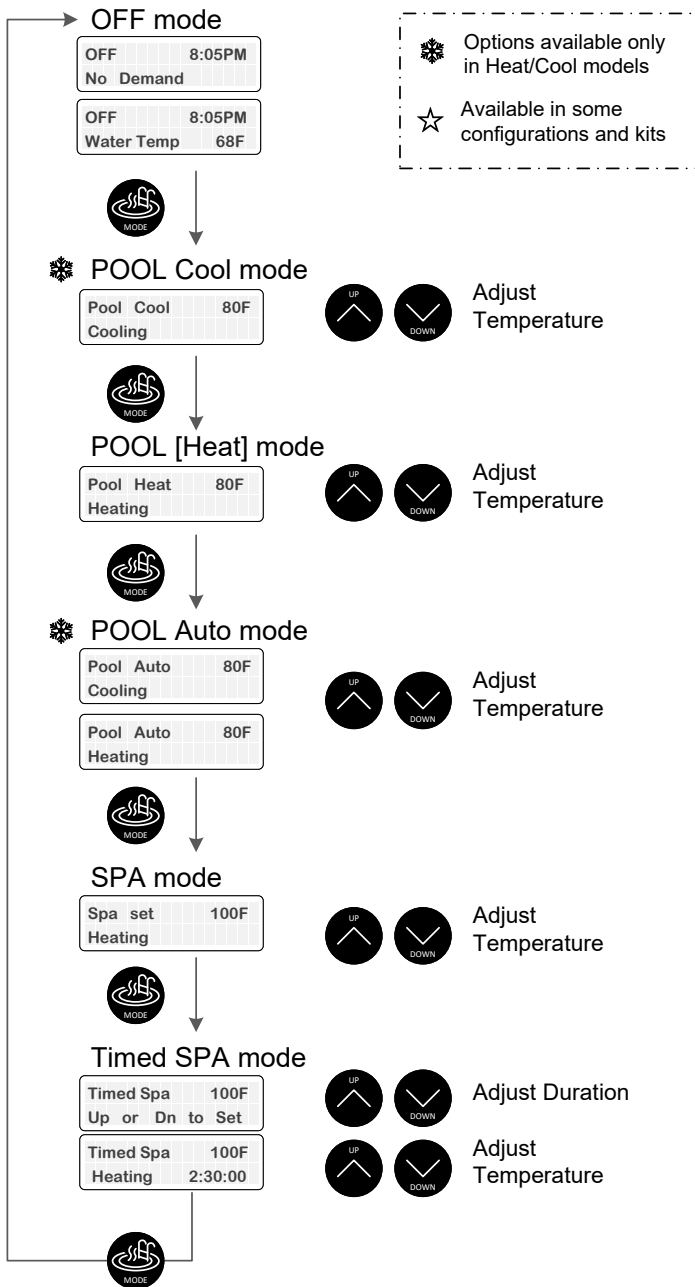
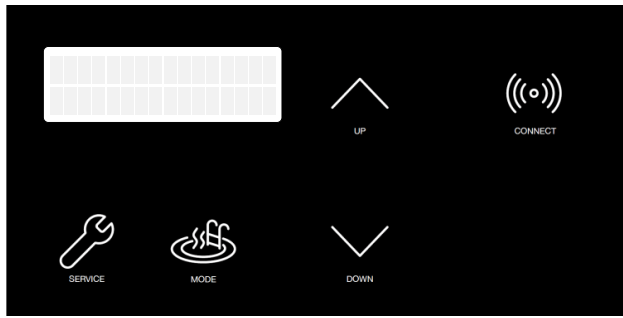

Figure 23. Operation and Service Screen



## 12. PROGRAM MENU ( + )

To access the PROGRAM menu, press and hold SERVICE and MODE keys simultaneously for 7 to 10 seconds until "Language" screen appears on the display.

This menu allows to change and reset the factory default settings, as well as providing access to the Installers and Schedule menus. There are different features and settings required for different model types. This section outlines the items noted on the display in Heat Only and Heat/Cool configurations, the default values and range of adjustable values and a description of the feature.

Any changes to values are stored into the non-volatile memory after selection is made using the UP or DOWN keys. Pressing SERVICE key toggles to the next setting. Failure to press any key for 5-minutes will cause the screen to return to Operation mode screen. The Program mode can also be exited by pressing the MODE key.

**CAUTION:** Changes to default program configurations could affect normal functionality of the heater.

### Language Selection

The initial display in PROGRAM Menus is "Language" selection.

The UP and DOWN keys will select English, Spanish or French language for all menus and Display messages.



Figure 24. Language Selection Mode

### Set Factory Defaults

Press the SERVICE key again. "Set Defaults" option is displayed. To set factory defaults, press and hold SERVICE and MODE keys simultaneously for 3 to 5 seconds until "Defaults Set" appears. This operation resets the operating program to its factory default values.

The pool setpoint is configured to 80°F (27°C), and the SPA setpoints will default to 100°F (38°C). The maximum temperature setting for pool and spa is limited to 95°F (35°C) and 104°F (40°C), respectively. The language is set to English, and the temperature display is set to Fahrenheit. The cooling deadband is set to 6°F (3.5°C), defrost temperature to 24°F (-4°C), defrost deadband to 10°F (5.5°C) and outside lockout to 45°F (7°C), respectively. The brownout is set to 230V, and the remote pool mode is set to Heat. The local schedule is disabled but not erased, and the "VS Pump Control" and other add-ons are also disabled. Note that cooling deadband and remote pool mode settings are only available in Heat/Cool models.

The "Control Lockout PIN" will be cleared, and the control will resume normal operation. See the "Control Lockout" section on page 14.

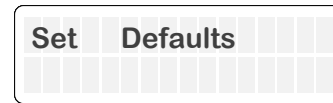

Figure 25. Set Defaults Option

### Reset Faults

Press the SERVICE key again. "Reset Faults" appears on the digital display. To clear faults history, press and hold SERVICE and MODE keys simultaneously for 3 to 5 seconds until "Faults Cleared" appears.

This function clears the historical fault available in SERVICE menu.

**NOTE:** When the unit is connected to Wi-Fi, the historical faults can be accessed in the timeline tab of Raymote. Reset faults do not affect historical faults registered in Raymote.

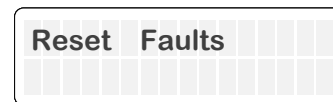

Figure 26. Reset Faults Option

### Wi-Fi Reset

Press the SERVICE key again. "Wi-Fi Reset" appears on the digital display. To clear stored Wi-Fi signal name and password, press and hold SERVICE and MODE keys simultaneously for 3 to 5 seconds until "Wi-Fi Initialized" appears.

This operation resets the Wi-Fi credentials, leaving the unit ready to configure connection with the Raymote app. For details on how to connect your pool heater to Raymote, follow the instructions on page 44.



Figure 27. Wi-Fi Reset Option

### Temperature Display

Press the SERVICE key again "Temp Display" appears on the digital display. The UP or DOWN keys will select "Fahrenheit" or "Celsius" on the temperature display. Choose the desired temperature scale. After making the selection, all temperature screens will be updated to display degrees in either Fahrenheit or Celsius.



Figure 28. Temperature Display Option

## Spa Setpoint Maximum Adjustment

Press the SERVICE key again. "Spa Max Temp" appears on the digital display. Using the UP and DOWN keys will change the maximum temperature setting to your desired value. The control can be set to limit the maximum setpoint in the range of 65°F to 104°F (18°C to 40°C). The default value is 104°F (40°C).

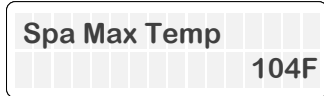

Figure 29. Spa Setpoint Maximum Adjustment Option

## Pool Setpoint Maximum Adjustment

Press the SERVICE key again. "Pool Max Temp" appears on the digital display. Using the UP and DOWN keys will change the maximum temperature setting to your desired value. The control can be set to limit the maximum setpoint in the range of 65°F to 95°F (18°C to 35°C). The default value is 95°F (35°C).

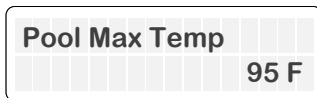

Figure 30. Pool Setpoint Maximum Adjustment Option

## Cooling Deadband Adjustment - (Heat/Cool Models Only)

Press the SERVICE key again. "Cooling Deadband" appears on the digital display. Using the UP and DOWN keys will change the cooling deadband setting. In POOL AUTO mode, the cooling setpoint is the heating setpoint minus this cooling deadband value. This setting can be set in the range of 2°F to 10°F degrees (1°C to 5.5°C). The default value is 6°F (3.5°C).

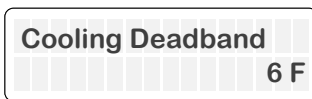

Figure 31. Cooling Deadband Adjustment Option

## Remote Pool Mode - (Heat / Cool Models Only)

Press the SERVICE key again. "Remote Pool Mode" appears on the digital display.

When Remote mode (3-wire selector) is enabled, and the unit is a Heat/Cool model, this setting can be used to define the operation mode of the "Pool" wire selector. Use UP and DOWN keys to set Remote pool mode to Pool Heat, Pool Cool or Pool Auto. The default value for remote pool mode is "Heat".

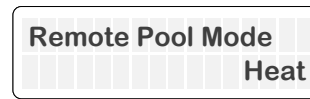

Figure 32. Remote Pool Mode Option

## Defrost Temperature Adjustment

To adjust the defrost temperature, press the SERVICE key and select "Defrost Temp" on the digital display. Use the UP and DOWN keys to adjust the temperature setting, which is measured on the coil during defrost mode. The range of available settings is 20°F to 35°F (-6.5°C to 1.5°C), with a default value of 24°F (-4°C).

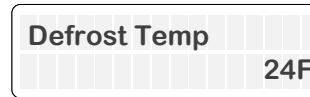

Figure 33. Defrost Temperature Adjustment Option

## Defrost Deadband Adjustment

To adjust the defrost deadband, press the SERVICE key and select "Defrost Deadband" on the digital display. Use the UP and DOWN keys to adjust the deadband setting, which determines when defrost mode ends based on the coil temperature. The defrost cycle ends when the coil temperature is higher than the Defrost Temperature plus the Defrost Deadband. You can set this value in the range of 5°F to 20°F (2.5°C to 11°C), with a default value of 10°F (5.5°C).



Figure 34. Defrost Deadband Adjustment Option

## Outside Lockout Temperature Adjustment

To adjust the outside lockout temperature limit, press the SERVICE key and select "Outside Lockout" on the digital display. Use the UP and DOWN keys to set the ambient temperature at which the unit will be locked out of operation. This setting can be adjusted in the range of 30°F to 50°F (-1°C to 10°C), with a default value of 45°F (7°C).

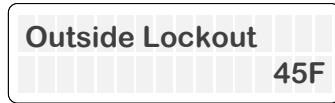

Figure 35. Outside Lockout Temperature Adjustment

## Brownout Detection Mode

To adjust the brownout detection mode, press the SERVICE key and navigate to "Brownout Detect" on the digital display. You can then use the UP and DOWN keys to choose from three options: 230V, 208V, or Disabled. Enabling brownout detection will cause the unit to shut down automatically if the Transformer's 24VAC signal drops below a certain threshold, specifically below 21VAC for 230V or below 24VAC for 208V. This function is intended to protect the unit from low voltage situations. If you prefer not to use this feature, simply select "Disabled". The default setting for brownout detection is 230V.



Figure 36. Brownout Detection Mode Option

**NOTE:** Disabling "Brownout Detection" limits the ability of the heater to protect the compressor.

## Installer Menu

To access the Installer Menu, press the SERVICE key and select "INSTALLER Menu" on the digital display. You can use the UP key to enter the Installer menu, or press SERVICE to move to the next option. For more details on the "Installer Menu", please refer to page 21.

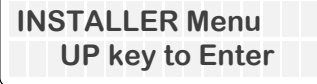

Figure 37. Installer Menu Option

## Schedule Menu

To access the SCHEDULE Menu, press the SERVICE key and select "SCHEDULE Menu" on the digital display. You can use the UP key to enter the Schedule menu and editor, or press SERVICE to return to the beginning of the Program menu. For more information on the "Schedule Menu", please refer to page 25.

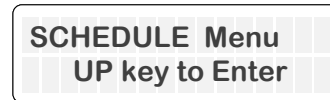

Figure 38. Schedule Menu Option

# Program Menu Diagram

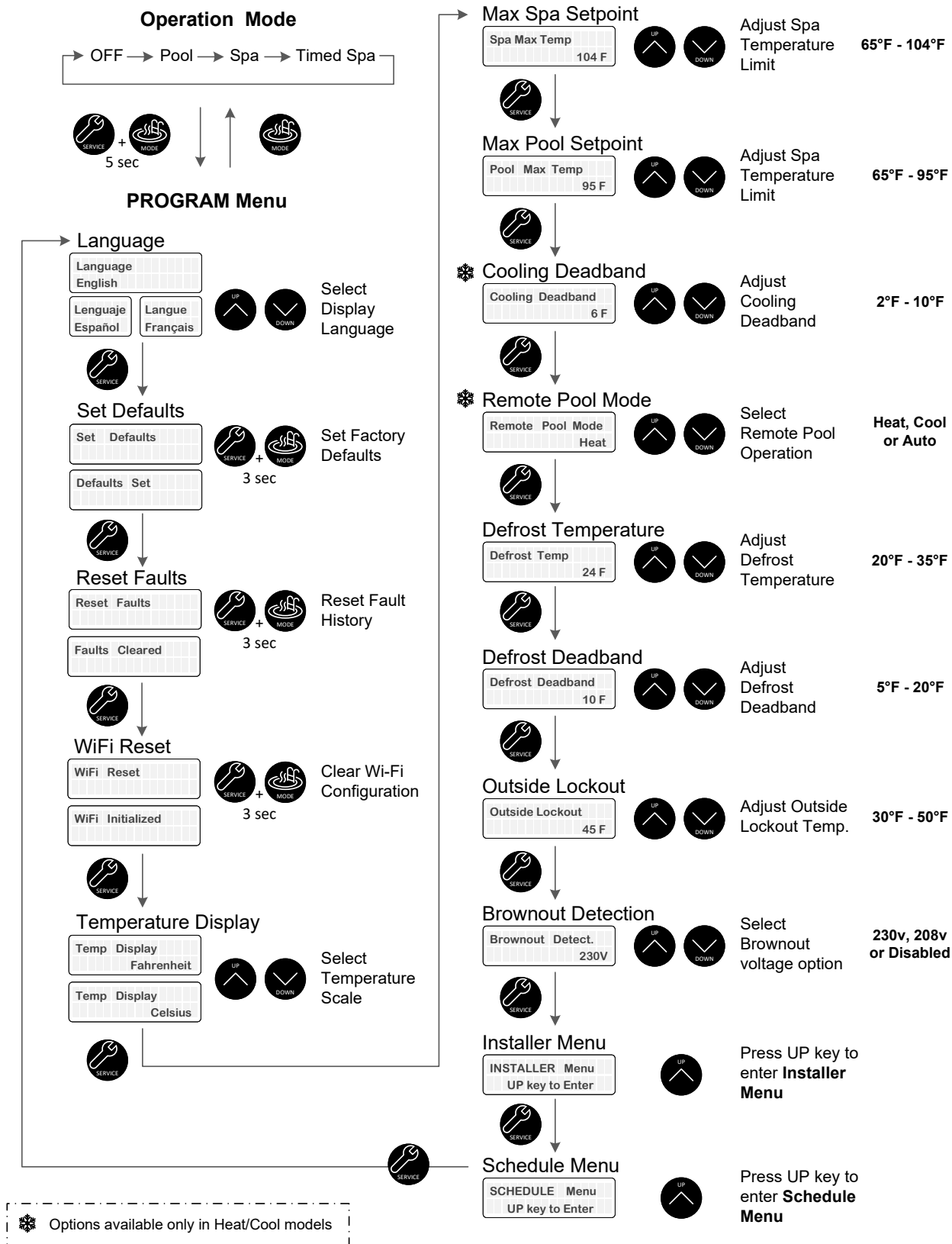

Figure 39. Program Menu

### 13. INSTALLER MENU

The Installer menu shows the options to control external devices like pumps, valves, and auxiliaries, directly from the heat pump built-in scheduler or Online Raymote automation.

"Installer Menu" can be accessed from the program menu. Use the UP key to enter in the Installers menu or press SERVICE to skip to the next option.

- Use the SERVICE key to move along the options of the Installer menu.
- Use the UP and DOWN keys in each screen to adjust and select operation modes and settings.
- Use MODE key to return to the "Program Menu".

#### Auxiliary Output 1 & 2 Operation Modes

When entering the INSTALLER menus, the displays will show "Auxiliary 1 mode" and "Auxiliary 2 mode." On each screen, you can choose an operation mode using the UP and DOWN keys. These modes include:

- **Raymote:** which allows Wi-Fi control using Raymote online automation.
- **Schedule:** which allows the heat pump built-in clock and schedule to control the auxiliary.
- **Auxiliary Heat:** which configures the auxiliary to turn on an external heater. The control will turn on the auxiliary automatically if the water temperature is 10°F lower than the pool or spa heat setpoint. The unit will turn off the auxiliary when heat demand is satisfied.

The default value for the 'Auxiliary 1' and 'Auxiliary 2' operation modes is the Raymote mode.

For details regarding auxiliary wiring, refer to section 27, "Optional Control Outputs", on page 72.

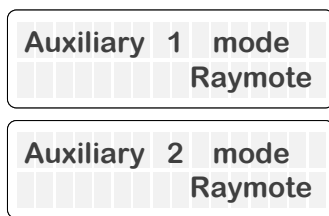

Figure 40. Auxiliary Output Operation Modes

#### Single-Speed Pump Operation Mode

To access the "Single-Speed Pump" operation mode, press the SERVICE key again, and the digital display will show "Single-Speed Pump." To select an operation mode, use the UP and DOWN keys and choose from the following options:

- **Raymote:** The single-speed pump output is set to be controlled from Wi-Fi with Raymote online automation.
- **Schedule:** The single-speed pump output is set to be controlled by the heat pump built-in clock and schedule.
- **Heater Demand:** The single-speed pump output is set to turn on when the heater starts the heating or cooling operation. The unit turns the single-speed pump output off when heat demand is satisfied.

The default value for single-speed pump output operation mode is "Disabled". This function can be used with the control board terminal P5 labeled as "PUMP." For details about single-speed pump wiring, refer to section 27, "Optional Control Outputs", on page 72.

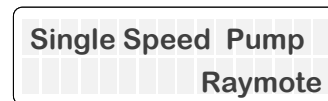

Figure 41. Single-Speed Pump Operation Mode

#### Variable-Speed Pump Operation Mode

When you press the SERVICE key again, the digital display will show "VS Pump Control." To select an operation mode, use the UP and DOWN keys and choose from the following options:

- **Disabled:** The Variable-Speed Pump functions are disabled, and no commands are sent to the external pump.
- **Protégé VSP:** The heater uses a 4-pin terminal P12 labeled as "COM" to command an external Raypak Protégé Variable-Speed Pump.
- **4-Speed Control:** The heater's 4-speed control is achieved by using the 5-pin digital outputs located in the terminal P8 labeled "VAR PUMP" to command an external variable-speed pump that is compatible with 30V DC signals supplied by the heater.

By default, the variable-speed pump output operation mode is set to "Disabled". For more information about the wiring of the variable-speed pump, refer to section 27, "Optional Control Outputs", on page 72.

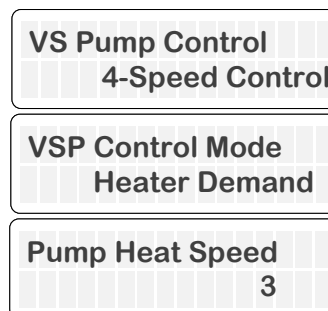

Figure 42. Variable-Speed Pump Operation Mode

When the variable-speed pump control is enabled, the menu "VSP Control mode" becomes available. Use the UP and DOWN keys to choose from the following options:

- **Raymote**: which allows Wi-Fi control using Raymote online automation.
- **Schedule**: which allows the heat pump built-in clock and schedule to control the variable-speed pump.
- **Heater Demand**: The variable-speed pump output is set to turn on when the heater starts the heating or cooling operation. The unit commands the variable-speed pump output per the setting selection in the **Pump Heat Speed** screen.

## Valves Control

Press the SERVICE key again to access the "Valves Operation" menu, where you can select the operation mode of the valve control outputs. By default, this function is disabled. Use the UP and DOWN keys to choose from the following options:

- **Raymote**: which allows Wi-Fi control using Raymote online automation.
- **Pool-Spa**: which configures the valve actuator outputs to be commanded automatically when Pool or Spa mode is set in the heater.

By default, the valve control mode is set to "Raymote". For more information about the wiring of the valve outputs, please refer to section 27, "Optional Control Outputs", on page 72.



Figure 43. 3-Way Valve Control

## Valves Outputs Position Selection

Press the SERVICE key again. When "Valves Control" mode is set to "Pool-Spa", you'll see the "Valve 1" and "Valve 2" options on the digital display. This function uses the "VALVE 1" and "VALVE 2" terminals of the control board. To associate Valve 1 and Valve 2 with the "Position 1" of either the pool or spa operation mode, use the UP and DOWN keys on the control panel. For more information on valve control output wiring, please refer to section 27, "Optional Control Outputs", on page 72.

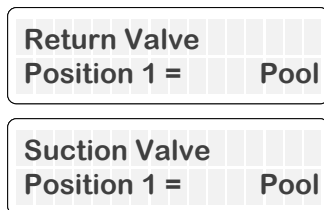

Figure 44. Valve 1 and 2 Outputs Position Selection

## Solar Heating Integration (Heat/Cool Models Only)

To access the "Solar Heating" function, press the SERVICE key again. The digital display will show "Solar Heating". By default, this feature is disabled. You can use the UP and DOWN keys to enable or disable solar heating integration.

When enabled, the controller will monitor the temperature of a field-supplied 10K temperature sensor connected in the input terminal P11. The controller adjust the position of the solar 3-way valve connected to terminal P9, to deliver water either to the solar heater or the heat pump. See Section 27, page 83, for details regarding Solar Heating integration.

When Solar Heater is enabled, the heat pump commands the solar 3-way valve (P9) to direct the flow from the filtration system to the solar heater and finally to the heat pump. This operation mode works only during day time hours 8:00 a.m. to 5:00 p.m. When the unit is connected to Raymote the daytime hours are automatically set by the estimated location of the heater.

The Solar heater integration works as follows:

- The solar 3-way valve is set to deliver hot water from the solar heater for a laps of 3-minutes minimum.
- If the water temperature of the solar heater is 3°F (1.5°C) above pool water temp, the solar 3-way valve remains active delivering water from the solar heater.
- The solar valve is set to "heat pump" position when demand for heat is satisfied or when the solar temperature is less than 3°F (1.5°C) in comparison with pool water temperature.
- When solar temperature is less than 3°F (1.5°C), and heat demand is active, the heat pump will command the solar 3-way valve to close, bypassing the solar collector and passing water directly to the Heat Pump. If demand for heat prevails after 2-hours, the solar valve is opened again to test the temperature in the solar heater.
- The heat pump will work simultaneously with the solar heater until the heat demand is satisfied.

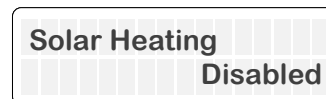

Figure 45. Solar Heating Integration

When Solar Heater is enabled, the solar sensor is considered the inlet water sensor for the system.

The following parameters can be adjusted when solar heater is enabled:

- Solar 3-way valve position selection
- Solar heater temperature limit
- Solar heater retry time
- Solar deadband

The following paragraphs describe the functionality of each parameter. For more information on Solar heater integration and wiring, please refer to section 27,

"Optional Control Outputs", on page 72.

## Solar Valve Position Selection (Heat/Cool Models Only)

To access the "Solar Valve" position selection, press the SERVICE key again. When the "Solar Heating" option is enabled, the "Solar Valve" option will appear on the digital display. The "Solar Valve" option uses the 3-pin terminal P9 labeled as "SOLAR". Use the UP and DOWN keys to associate the Solar valve "Position 1" to either "Heat Pump" or "Solar Heater". For more information about the solar valve sensor wiring, please refer to section 27, "Optional Control Outputs", on page 72.



Figure 46. Solar Valve Selection

## Solar Heater Temperature Limit (Heat/Cool Models Only)

Press SERVICE again to access the "Solar Delta" setting. This setting determines the minimum water temperature delivered by the solar heater to keep the solar 3-way valve directing flow to the solar heater. Use the UP and DOWN keys to adjust this parameter from 0°F to 10°F (0°C to 5.5°C). The default value is 3°F (1.5°C).

When this setting is set to 0°F (0°C), the solar 3-way valve remains active as long as the water delivered by the solar heater is not losing heat.



Figure 47. Solar Delta Selection

## Solar and HPPH Deadband (Heat/Cool Models Only)

Press SERVICE again to access the "Solar Deadband" setting. This setting determines the temperature limit of the heat pump operation while the solar heater is supplying hot water. Use the UP and DOWN keys to adjust this parameter from 0°F to 20°F (0°C to 11°C). The default value is 0°F.

When this setting is set to 0°F, the heat pump operation remains active until the demand for heat is satisfied. For example, if the Solar deadband is set to 5°F, the heat pump keeps heating until the water temperature sensed by the solar sensor is 5°F or less from the water temperature setpoint.



Figure 48. Solar Deadband Selection

## Solar Heater Retry Time (Heat/Cool Models Only)

Press SERVICE again to access the "Solar Retry Time" setting. This setting determines the period of time to check again the solar heater delivery. Use the UP and DOWN keys to adjust this parameter from 2 to 4 hours. The default value is 2-hours.

This setting is used when the solar heater water temperature is below the solar limit (Solar delta). In this case, the heat pump controller uses this time to retry using the solar heater.



Figure 49. Solar Retry Time

For more information on Solar heater integration and wiring, please refer to section 27, "Optional Control Outputs", on page 72.

## Auxiliary Input

Press the SERVICE key once again to access the "Auxiliary Input" menu, where you can enable and choose the functionality of an optional Auxiliary input. By default, this feature is disabled. Use the UP and DOWN keys to select from the following options:

- **Disabled:** The input is disregarded.
- **Warning:** The Fault "Aux Input Warning" is shown in the LCD and Raymote if the auxiliary input in terminal P11 is open. The unit continues its operation, but the fault is reported and recorded in the fault history.
- **Interlock:** The Fault/interlock "Aux Input Fault" is displayed in the LCD and Raymote. The operation of the heater is prevented or terminated until Input P11 is closed again.



Figure 50. Auxiliary Input

For more information about the Auxiliary input wiring, please refer to section 27, "Optional Control Outputs", on page 72.

# Installer Menu Diagram

**INSTALLER MENU OPTIONS**  
 The Installer menu shows the options to control external devices directly from the Heat Pump built-in scheduler or from Raymote app online automation.

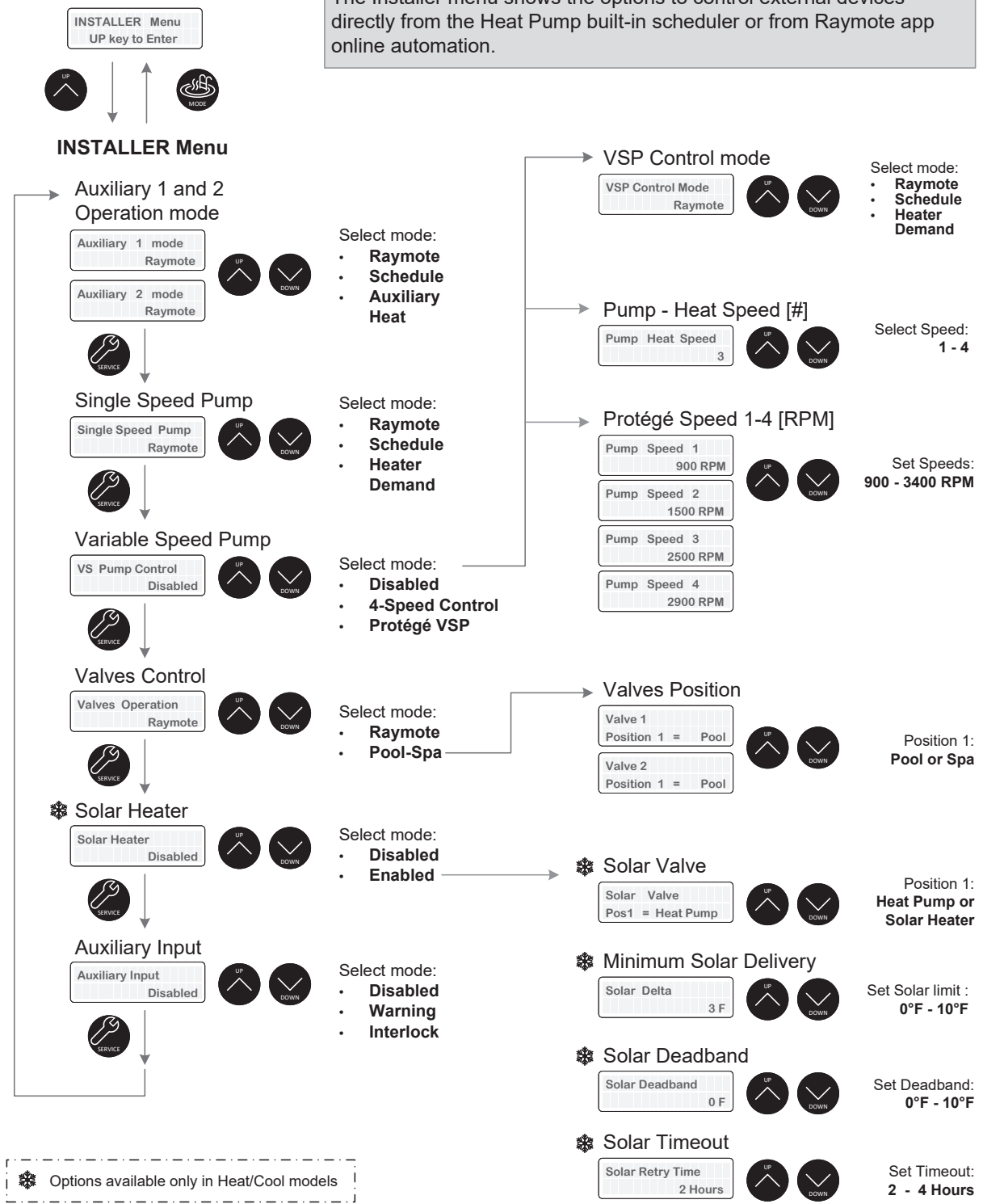

Figure 51. Installer Menu



## 14. SCHEDULE MENU

**NOTE:** The Schedule menu can be used to configure automatic control of external devices directly from the Heat Pump built-in scheduler. By default, internal control is set to “Raymote” Wi-Fi control. To control external devices with the built-in schedule, use the Installer menu to configure control mode of the external devices to “Schedule mode”.

The schedule menu shows the options to configure the heat pump built-in scheduler. See Figure 53. This local schedule works with the built-in clock and allows the user to run up to 4-events per day, like controlling pumps, auxiliary outputs, and operation mode automatically from the heat pump control board.

The schedule menu can be accessed from the Program menu.

- Use the SERVICE key to move along the options of the Schedule menu.
- Use the UP and DOWN keys in each screen to adjust and select number of events, start time, operation modes and other programmable settings.
- Use MODE key to return to the Program menu.
- To set times faster, press and hold UP or DOWN keys.

### Set Current Time

Press the SERVICE key again. "Set Current Time" option is displayed only when the heater is not connected to Wi-Fi. The control has a 24-hour time clock. This option allows setting of the current time. The time is followed by A.M. or P.M. When the unit is connected to Wi-Fi, the clock is set automatically.

Use the UP and DOWN keys to adjust the clock's time. Holding the UP or DOWN key accelerates the change in the numbers of the clock. Press the SERVICE key when completed to save the changes.

The time clock is used to run the events defined in the built-in schedule. Please refer to INSTALLER menu on page 21 to configure external devices like pumps, and auxiliaries.

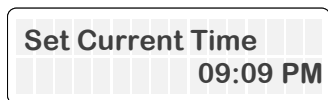

Figure 52. Set Time Option

### Set Time with Raymote

When the heater is connected to Wi-Fi, the clock will be updated by Raymote.

Make sure to use the correct Time zone and Location in the Raymote heater settings or Raymote organization settings.

The Time zone can be configured while connecting the unit to Wi-Fi or at any other time while the unit is connected to the Internet.

# Schedule Menu Diagram

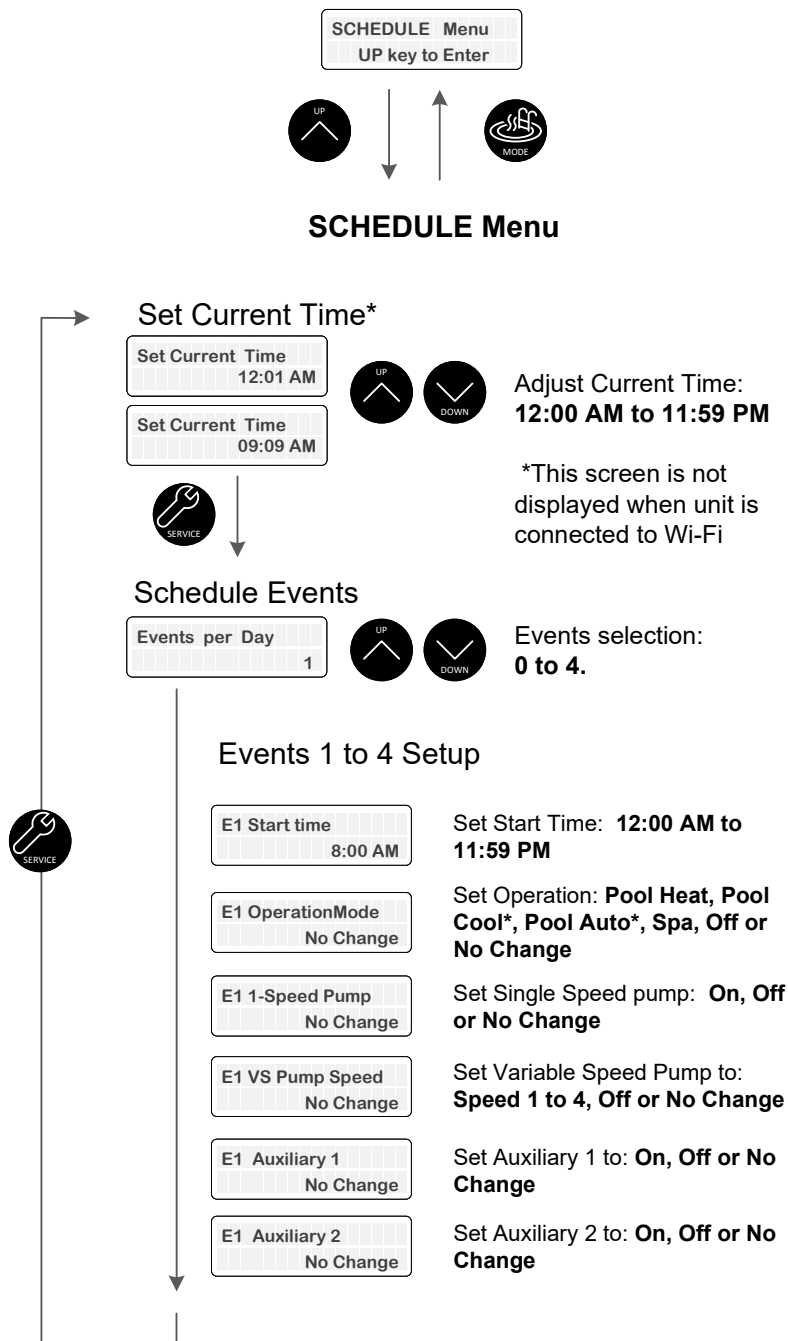

### Example:

Each Event executes a set of commands defined by the user. For example, if the single speed pump output needs to be turned on at 8:00 AM and turned off at 2:00 PM:

- Set "E1 start time" to **8:00 AM** and "1-Speed Pump" to **On**.
- Set "E2 start time" to **2:00 PM** and "1-Speed Pump" to **Off**.

Figure 53. Schedule Menu

## 15. DIGITAL CONTROLS OPERATION

Your heat pump pool heater incorporates digital safety controls and indicators to ensure safe and reliable operation. The pool water temperature is controlled by the heater's digital control system, which provides multiple operation modes as described in section 10, "Operation Modes," on page 12.

Furthermore, the unit is compatible with most "2-wire" and "3-wire" control/automation systems. For more information about 2 and 3-wire control, refer to section 16, "Remote Mode Selector", on page 31.

This section explains the general control sequence of operation, as well as the protections provided by the heater to ensure safe and dependable operation.

### Sequence of Operation

1. Upon the initial application of power, the heater control briefly illuminates all segments on the LCD at power-up.
2. The control displays the current software version on the LCD for 2-seconds, then resumes the user-selected mode it was in before power was interrupted.
3. If the unit type has not been set, the control prompts the user to set the model type before enabling any device operation.

**NOTE:** The model is set from the factory. If the model needs to be updated due to a board replacement, use the special menu "Model Type", available in the Installer menu. The Installer menu can be accessed from the Program menu. Refer to section 13, "Installer Menu", on page 21 for more information.

4. **Optional:** During the initial operation, there are several optional items that can be defined and programmed depending on the intended configuration and accessories to be controlled by the heater. These include control of valves, single-speed and variable-speed pumps, and auxiliary outputs. Once these options are selected, further information is required to establish the pump periods, pump speed during each period, and auxiliary outputs command for each period, which must be determined and set in the SCHEDULE menu for local automation or with Raymote app for remote control with Wi-Fi. Once programming is completed, the heater control is ready for operation.

**NOTE:** Optional control items are not enabled by default at the factory. To activate and configure these features, please refer to the "Installer" and "Schedule" menus. Both menus are accessible from the Program menu. Refer to section 13, "Installer Menu", on page 21 and section 14, "Schedule Menu", on page 25, for more information.

5. The user can select one of several operating modes depending on the unit type. To cycle between the modes, simply press the MODE key. Each press of the MODE key selects the next mode.
  - For Heat Only models, the available mode selections are OFF, POOL, SPA, and TIMED SPA.
  - For Heat/Cool models, the available mode selections are OFF, POOL COOL, POOL HEAT, POOL AUTO, SPA, and TIMED SPA.
6. During operation, the unit will run until the water temperature reaches 0.5°F (0.3°C) above the setpoint for heating (or below for cooling), or until the unit is manually turned off.
7. The unit will enter standby mode and wait for the next demand to start heating or cooling the water.

For more information, refer to section 10, "Operation Modes", on page 12. For information about the remote mode, please refer to section 16, "Remote Mode Selector", on page 31.

### System Start-Up

1. Ensure that the Digital Board is displaying the correct temperature and that the pool pump is running, and water is circulating properly.
2. Confirm that the Board is programmed with the desired temperature setpoint for the pool and/or spa.
3. Allow the heater to operate for a few minutes to stabilize the operating pressures and allow various component temperatures to normalize.
4. After the unit has been operating in heating mode for a few minutes, check that the discharge air temperature is approximately 8°F-10°F (4.4°C-5.5°C) cooler than the air entering the unit.
5. In Heat/Cool models, after the unit has been operating in cooling mode for a few minutes, the discharge air temperature should be 8°F-10°F (4.4°C-5.5°C) warmer than the air entering the unit.

**NOTE:** Heating is more efficient during warmer daylight hours, while cooling is more efficient during cooler nighttime hours. To speed up the cooling process, turn off the pool/spa blanket and turn on any fountains, sprays, or other water features at nighttime.

## Operational Status Messages

The LCD screen displays a range of status and diagnostic messages, depending on the operating conditions. The following status messages, will be shown in pool, spa, and remote modes when no active fault conditions are present.

Display	Condition
No Demand	Demand has been satisfied and the unit is in standby.
Heating	Unit is operating and running a heating cycle.
Cooling	Unit is operating and running a cooling cycle.
Defrost	Unit is performing a defrost cycle. Coil temperature is below defrost temperature limit. Verify defrost temperature and defrost deadband settings.
Comp Start Delay	Notification that the compressor is under a 3-minute delay before turning on.
Valve Chng Delay	Notification that the 3-way valves are being commanded to change positions pool to spa, or spa to pool.
Solar Heat	The solar heating setting is enabled, and running with the heat pump.
Outside Lockout	The compressor is not running because the ambient temperature is too cold as measured by the ambient sensor. Verify outside lockout temperature setting.

**Table D. Operational Status Messages**

## Error Messages

The following error messages are displayed in pool, spa, and remote modes. Consecutive identical faults are only stored once in the "Fault History".

**⚠ WARNING:** Performing service on this equipment requires specialized expertise, mechanical skills, tools, and equipment. If you do not possess these, it is not recommended to attempt any service on this equipment unless following the procedures outlined in this manual.

Display	Troubleshooting
In Sensor Fault	Inlet sensor fault - Check for low water flow conditions. Check pump speed. Check inlet sensor.
In Sensor Open	Inlet sensor fault - Sensor open. Check sensor wires and harness terminals.
In Sensor Short	Inlet sensor fault - Sensor short. Check sensor wires and terminals.
Out Sensor Open	Outlet sensor open - Check sensor wires and terminals.
Out Sensor Short	Outlet sensor shorted - Check sensor wires and terminals.
Amb. Sensor Open	Ambient temperature sensor open - Check sensor wires and terminals.
Amb. Sensor Shrt	Ambient temperature sensor shorted - Check sensor wires and terminals.
Flow Sensor Fail	Flow sensor fault - Readings out of range. Check flow sensor settings.
Check Pump Fault	Pump controller faulted - Check that pump controller status. Check configuration.
Coil Sensor Open	Coil sensor open - Check sensor wires and terminals.
Coil Sensor Short	Coil sensor short - Check sensor wires and terminals.
Pump Ctl Fail	Protégé pump is not responding - Check that pump is powered and connected. Check variable-speed pump settings.
Sensor Misplaced	Water inlet temperature is higher than outlet temperature while heating. Check sensors installation.
Internal Fault	Controller faulted - Memory corrupted. Power cycle unit. Replace main board.
Low Temp Lockout	Temperature lockout - Water temperature below is 36°F (2°C). Check water temperature. Check inlet sensor.
Hi Press Trip	High-pressure switch tripped - Check water flow, check refrigerant load
Lo Press Trip	Low-pressure switch tripped - Check refrigerant load
Hi Press Lockout	High-pressure lockout - Multiple pressure trips detected. Check refrigerant load
Lo Press Lockout	Low-pressure lockout - Multiple pressure trips detected. Check refrigerant load
Brownout	Low voltage in 24V transformer - Check voltage input 230v /208v
Clock Fault	Real time clock fault - Unable to read or set clock
Hi Water Trip	High-temperature water trip - Inlet water is higher than 106°F (41°C).
Hi Water Lockout	High-temperature water lockout - Inlet water is higher than 108°F (42°C).
Remote Error	Remote 3-wire selector fault - Pool and spa inputs are energized. Check 3-wire remote control terminals.
Water PS Open	Water pressure switch open - Check pump operation. Check water flow.
Outside Lockout	Outside lockout - Compressor not running because ambient too cold.
Hi Delta-T	High delta temperature between inlet and outlet. Check water flow. Check pump operation.
Heating Fail	Outlet temperature not higher than inlet temperature. Check compressor.
Cooling Fail	Outlet temperature not lower than inlet temperature. Check reversing valve.
Solar Sensor Open	Solar sensor open - Check sensor wires and terminals.
Solar Sensor Short	Soar sensor short - Check sensor wires and terminals.
Defrost Lockout	Defrost operation not effective. Confirm ambient conditions.
Aux Input Warning	Auxiliary input is open - Check heater. Check wiring and configuration of auxiliary input
Aux Input Fault	Auxiliary input is open - Check heater. Check wiring and configuration of auxiliary input
No Communication with Heat Pump	Communication harness between Main board and Keypad may be damaged or disconnected. Check wires or replace harness.

**Table E. Error Messages**

## Minimum Run Time

To ensure the compressor operates efficiently and has a longer lifespan, the control has set a minimum run time of 3-minutes. If the setpoint temperature is reached within 3-minutes, the compressor will continue to run for the remaining time, unless one of the following conditions occur: (1) the high-pressure switch is tripped, (2) the water-pressure switch is tripped, (3) the high-temperature limit is reached, or (4) the user selects the "OFF" mode.

## Compressor Start Delay

To prevent the compressor from short cycling, the control is programmed with a compressor start delay. The compressor will not be energized unless it has been off for at least 3-minutes. During this delay, the display will show "Comp Start Delay", until the 3-minute wait time is completed and the compressor starts.

## Water Pressure Switch

The control system includes a water pressure switch (or flow switch, if available) that is constantly monitored. If the compressor is required and the water pressure switch is open, the control system will prevent the compressor from starting and display the message "Water PS Open" on the screen.

## Defrost Operation

The control's defrost temperature limits vary depending on the unit's configuration, whether it is a Heat Only or a Heat/Cool unit.

The control initiates a defrost cycle when the coil temperature falls to the "Defrost Temp" limit established in the Program menu, which is 24°F (-4°C) by default. For Heat Only models, during the defrost cycle, the compressor will shut off, while the fan will continue to operate to pull warmer air across the coil for defrosting.

For Heat/Cool models, during the defrost cycle, the control shuts off the fan and activates the reversing valve, while the compressor remains running. This action directs the hot refrigerant gas to the coil for defrosting.

Once the control sees a rise in the coil sensor temperature equal to "Defrost Temp" + "Defrost Deadband", which is 10°F (-12°C) by default, or after 15-minutes have passed, the unit exits the defrost cycle and returns to normal heating operation based on the current water temperature and setpoint temperature.

## Low Ambient Temperature - Outside Lockout

The control features a Low Ambient Temperature Lockout function that prevents operation when the ambient temperature falls below the "Outside Lockout" temperature limit. You can access this setting through the Program menu, and the default value is 45°F (7°C). However, the temperature limit is adjustable, and you can set it between 30°F (-1°C) and 50°F (10°C) according to your needs.

## High Water Temperature Limit

If the compressor is demanded and the inlet water temperature is 106°F (41°C) or higher, the control will prevent compressor start, allow the pump to run, and show "Hi Water Trip" on the second line of the LCD. The fault is removed only when the water temperature drops below 106°F (41°C).

In the event that the inlet water temperature sensor reads at or above 108°F (42°C) while the compressor is running, the control will shut down the compressors and display "Hi Water Lockout" on the second line of the LCD. The compressors will remain locked out until the inlet sensor reading falls below 103°F (39°C).

This high-temperature limit is active in all modes of operation, including cooling operation (heat/cool models), in case of a reversing valve failure. High water temperature is ignored if there is no demand for the compressor.

## High-Pressure Switch Lockout

In the event that the high-pressure switch opens, the control turns off the compressor output, and the fan will continue to operate for 15-minutes after the High-Pressure Switch (HPS) opens. Additionally, the display will show "Hi Press Trip."

If the high-pressure switch trips 7-times within a single cycle, the display will show "Hi Press Lockout," and the unit will be disabled for 4-hours. The unit will automatically reset after 4-hours, or the lockout can be manually reset by pressing the MODE key or by power cycling. It is important to note that the high-pressure switch must remain closed for a minimum of three-seconds for the control to recognize that it has closed.

## Low-Pressure Switch Lockout

The control has a 30-second grace period after the compressor is energized during which it will ignore an open low-pressure switch. However, if the low-pressure switch remains open for 3 or more seconds after this period, the compressor will shut down and the display will show "Lo Press Trip".

In the event that the low-pressure switch trips 6-times within a single cycle, the control will display "Lo Press Lockout" and the unit will be disabled for 4-hours. After the 4-hour period has elapsed, the unit will automatically reset. Alternatively, the lockout can be manually reset by power cycling the unit. It's important to note that the low-pressure switch must be closed for at least 3-seconds in order for the control to recognize it as closed.

# 16. REMOTE MODE SELECTOR

**⚠ WARNING** The ability to properly perform service on this equipment requires a certain level of expertise, mechanical skills, and access to the necessary tools and equipment. If you do not possess these, do not attempt to perform any service on this equipment other than those procedures recommended in this manual.

The heater controller is remote-ready. The digital display shows the actual pool temperature, operating status, and service messages. The touch keys on the control panel allow you to select the desired pool or spa temperature before the remote mode is enabled. The LCD indicates when a remote system is controlling the heater by displaying "Remote" on the display. When connecting the heater to a remote system, identify whether it is a two- or three-wire remote system.

- REMOTE mode is accessed by pressing and holding the UP and DOWN keys simultaneously for 3-seconds.
- If the UP, DOWN, or MODE keys are pressed while in REMOTE mode, the display will read "Exit Remote Mode to Adjust Temp". The mode and temperature set points are not changed.
- Press and hold the UP and DOWN keys for 3-seconds to exit REMOTE mode. When exiting REMOTE mode, the control always selects the OFF mode.

Select the appropriate instruction listed in the following paragraphs to properly install the remote to the heater.

## Remote Wiring Connector

The heaters are equipped with the ability to work with external remote controls and automation systems. The supplied 3-pin remote wiring located in the packaging installed on connector "P7" supplies power out to either a toggle switch or the switch contacts of a third-party automation controller. The remote works by either making or breaking the circuit created by the remote wiring.

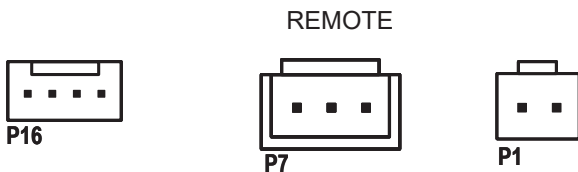

Figure 54. Remote Wiring Connector

**NOTE:** Typically, a remote automation controller does not supply power to the heater, it only provides a switching function to turn the heater On or Off. If your remote controller is supplying its own voltage to the heater, it will not work with this heater and may damage the digital circuit board.

## Activating the Remote Mode

To activate or deactivate the remote mode, press and hold the UP and DOWN arrow keys simultaneously for 3 to 5-seconds.

The first line in the LCD displays "Remote" and "Off", "Pool" or "Spa" and the temperature setpoint. The second line of the LCD displays "Water Temp" and water temperature alternating with heater status message. See Figure 55.

## REMOTE MODE ENABLED

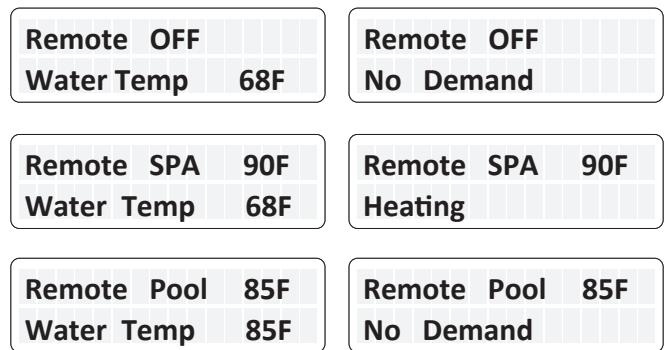
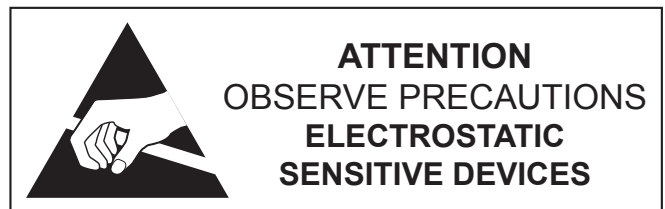

Figure 55. Remote Operation Modes

## Remote Control Wiring



**⚠ CAUTION:** Electrostatic Discharge (ESD) damage can be caused by direct or indirect contact with the wiring or circuit board. When one walks to the heater area, an electrostatic charge accumulates on the body. Contact of a finger allows the body to discharge, possibly causing device damage. This damage can be limited if the service person discharges himself, following ESD preventive/removal practices, and holds on to the heater enclosure for 5-seconds before proceeding.

## Important Installation Notes for Remote or External Wiring Configuration:

- Remote wiring must be run in a separate conduit.
- Remote wiring must not be run parallel to high voltage lines.

- For runs of under 30 feet (9 m), remote wiring should have stranded conductors with a minimum of 22 AWG, 600V, cable twisting 1.5" to 2.5" (3.8 to 6.4 cm) lay and jacketed.
- For runs over 30 feet (9 m), the conductors should be a minimum of 20 AWG, 600V, cable twisting 1.5" to 2.5" (3.8 to 6.4 cm) lay that is shielded and jacketed.
- Maximum cable length recommended is 200 feet (61 m).
- For both two- and three-wire remote systems, the provided 3-pin REMOTE connector "P7" must be utilized.

**NOTE:** The remote wires must be connected to the 3-wire remote interface harness before the connector is plugged into the board.

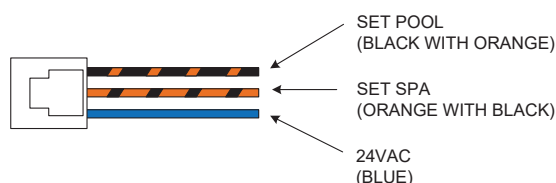

Figure 56. 3-Wire Remote Harness

## 2-Wire Remote Control (On-Off)

This application assumes that only one heating function (pool or spa) is required.

1. Turn on power to the heater.
2. For a remote controller without its own thermostat, push the MODE key to the "POOL" or "SPA" mode and set the desired setpoint (e.g. 102°F (39°C) for spa).
3. For a remote controller with its own thermostat, push the MODE key to select "POOL" or "SPA" mode and set the temperature to the highest setting available on the control. The actual setpoint will be controlled by the remote controller.
4. Turn the MODE button to "OFF" and remove power from the heater.
5. On the 3-wire remote harness, connect the BLUE wire to one side of the remote automation controller and connect the other side to either the ORANGE/BLACK wire for "SPA" operation or the BLACK/ORANGE wire for "POOL" operation. See Figure 57.
6. Attach wire nut on the unused wire of the harness.

7. Install the "3-wire Remote Harness" to the "P7" connector and turn power "ON" to the heater. See Figure 57.
8. Activate remote mode in the heater. Press and hold the UP and DOWN arrow keys simultaneously for 3 to 5-seconds.

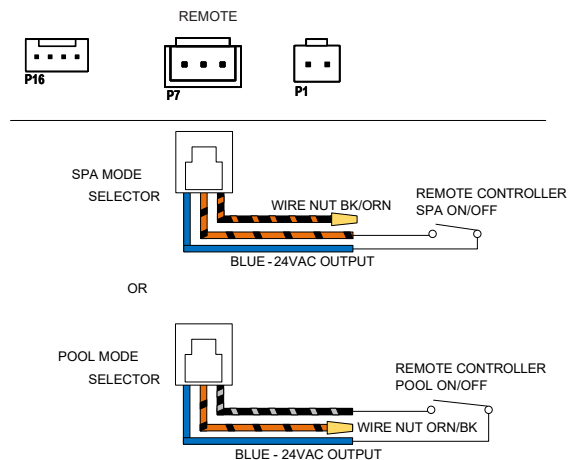

Figure 57. 2-Wire Remote Harness Installation

## 3-Wire Remote Control Using Three-Position Selector (Pool-Off-Spa, or Low-Off-High)

This application assumes that both heating functions (pool and spa) are required.

1. Turn on power to the heater.
2. For remote controllers without its own thermostat, push the MODE key to the "POOL" or "SPA" mode and set the desired temperature for each, e.g. 80°F (27°C) for Pool and 102°F (39°C) for spa.
3. For remote controller with its own thermostat, push the MODE key to select "POOL" or "SPA" mode and set both temperature setpoints to the highest setting available on the heater. The actual setpoint will be controlled by the remote controller.
4. Turn the MODE key to "OFF" and remove power from the heater.
5. On the 3-wire remote interface harness, connect the BLUE wire to one side of the remote automation controller and connect the ORANGE/BLACK wire for "SPA" operation and the BLACK/ORANGE wire for the "POOL" operation. See Figure 58.
6. Install the 3-wire remote interface harness to the "P7" connector and turn power ON to the heater. See Figure 58.



7. Activate remote mode in the heater. Press and hold the UP and DOWN arrow keys simultaneously for 3 to 5-seconds.

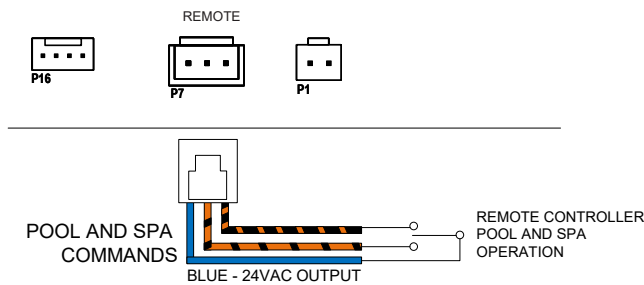
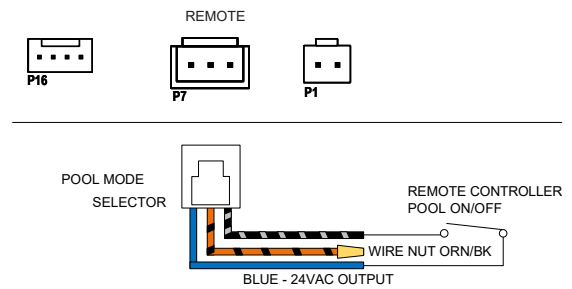

**Figure 58. 3-Wire Remote Harness Installation**

## Remote Control Options for Heat/Cool Models

In Heat/Cool models, the 3-wire remote "Pool" terminal can be configured to operate as "Pool Heat", "Pool Cool" or "Pool Auto". The default mode for remote pool is "Pool Heat".

1. To change this setting enter "Program Menu" by pressing and holding SERVICE + MODE keys simultaneously for 7-10 seconds.
2. Press SERVICE key until "Remote Pool Mode" is displayed.
3. Use the UP or DOWN keys to select "Pool Cool", "Pool Auto" or "Pool Heat".
4. After selection is completed, press MODE key to exit the "Program Menu".
5. For remote controllers without its own thermostat, use the MODE key to select the pool mode (pool heat, pool cool or pool auto). Then use the UP/DOWN keys to adjust the temperature setpoint to be used in remote mode.
6. For remote controller with its own thermostat, push the MODE key to select the pool mode (pool heat, pool cool or pool auto) and set the temperature setpoints to the highest/lowest setting available on the heater. The actual setpoint will be controlled by the remote controller.
7. Turn "OFF" with MODE key and remove power from the heater.
8. For a 2-Wire remote control, connect the BLUE wire to one side of the remote controller and connect the other side to the BLACK/ORANGE wire for "POOL" operation.
9. Attach wire nut on the ORANGE/BLACK wire of the 3-wire remote harness. See Figure 59.



**Figure 59. 2-Wire Remote Harness Installation**

10. For 3-wire control, connect the BLUE wire to one side of the remote controller and connect the ORANGE/BLACK wire for "SPA" operation and the BLACK/ORANGE wire for the "POOL" operation. See Figure 58.
11. Install the 3-wire remote harness to the "P7" connector and turn power ON to the heater.
12. Activate remote mode in the heater. Press and hold the UP and DOWN arrow keys simultaneously for 3 to 5-seconds.

## 17. SEASONAL START-UP OR ANNUAL CHECK

**NOTE:** At the beginning of the heating season or whenever the pool water temperature is to be raised several degrees, the pool pump and heat pump pool heater may need to operate continuously for several days. During summer months, only a few hours per day may be necessary or none at all.

1. Remove leaves, pine needles, etc., from the evaporator coil. Clean the coil by gently applying a mild solution of household liquid soap and water.
2. Remove the side louvered panel by removing the single screw at the top and the two (2) screws on the middle part of the panel. Lift and pull the bottom out. The panel will easily come away from the cabinet giving access to the coil for cleaning.
3. Gently rinse the coil with water; DO NOT use high pressure.
4. Re-install the side panels and secure each with the screws removed in Step 2.
5. Backwash or otherwise clean the pool filter. If necessary, clean the skimmer basket and pump strainer.
6. Set the valves to ensure proper water flow through the unit.

**NOTE:** If the pool pump and heat pump pool heater shut OFF before the water temperature is raised to the desired level, you must lengthen the running time of both. To do this, reset the time clock dial for the longer running time, or manually operate the pump with the timer override switch. Since the heater capacity and efficiency are both greater at higher ambient air temperatures, run time should be set to take advantage of all daylight hours, when the air is generally warmer.

## 18. SUMMER SHUTDOWN

If you do not plan to use the heater during the summer months, secure and protect it as follows:

1. Turn the unit circuit breaker or disconnect switch to OFF.
2. Leave the valves set the way they are unless additional circulation is required. DO NOT stop all flow through the heater.
3. **IMPORTANT:** Remember to reset the valves before the next heating season, or the unit will not operate properly.

## 19. FREEZE PROTECTION

If the unit is installed in a location subject to freezing conditions, it is important to protect the water circuit from freezing, just as should be done for the pump and filter.

## System Drain-Down

1. Turn the unit circuit breaker or disconnect switch to OFF.
2. With the pool pump OFF, close the external shut-off valves and remove the drain plugs located in the inlet and outlet water unions to allow water to drain. See Figure 60.

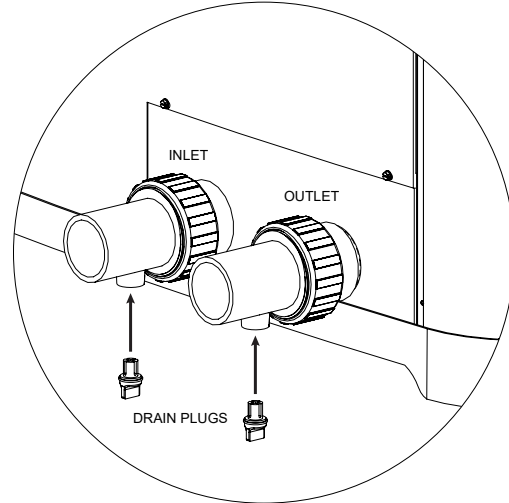

Figure 60. Drain Plug Locations

3. Use a wet/dry vacuum or air pressure to remove excess water, as necessary.
4. Once the water is drained, reinstall the drain plugs.
5. Cover the unit with a waterproof cover.

## Continuous Pump Operation

It is also possible in some areas to prevent unit freeze damage by operating the pump continuously during freezing weather. However, this results in significantly higher pump operating costs. Further, if a sustained power failure occurs, the unit MUST be drained anyway, or freeze damage could result.

**NOTE:** The heater manufacturer is not responsible for maintenance adjustments.

## 20. MAINTENANCE

The following maintenance procedures are designed to keep your unit operating at a high-level of reliability. Maintenance must be performed on a periodic basis to maintain warranty coverage and prevent system failures and performance degradation.

**CAUTION:** To clean the fins, remove the side louvered panels and spray gently with a garden hose. DO NOT pressure wash. Doing so will bend the fins and can void the warranty.

## Air Coil Cleaning

Efficient operation depends on free circulation of air through the thin and tightly-spaced fins of the evaporator coil(s). The evaporator must be cleaned whenever it has a buildup of dirt or debris.

## Cabinet Care (optional)

**⚠ WARNING:** Shut OFF electricity to the unit before cleaning.

The powder-coated cabinet is designed for outdoor use and requires little care. However, you can clean it if you wish. Wash the cabinet with soap and water.

## Unplug Condensation Drain Holes

The unit extracts humidity from the air as it passes through the coil, similar to the way a cold drink outside “sweats” on a hot day. This condensation drains from the bottom of the unit.

1. Routinely check to be sure the condensation drain holes in the base of the unit are not plugged with dirt or debris. See Figure 61 for condensate drain hole locations.
2. If condensation becomes a problem, optional drain pans may be available from your heat pump pool heater distributor or pool dealer.

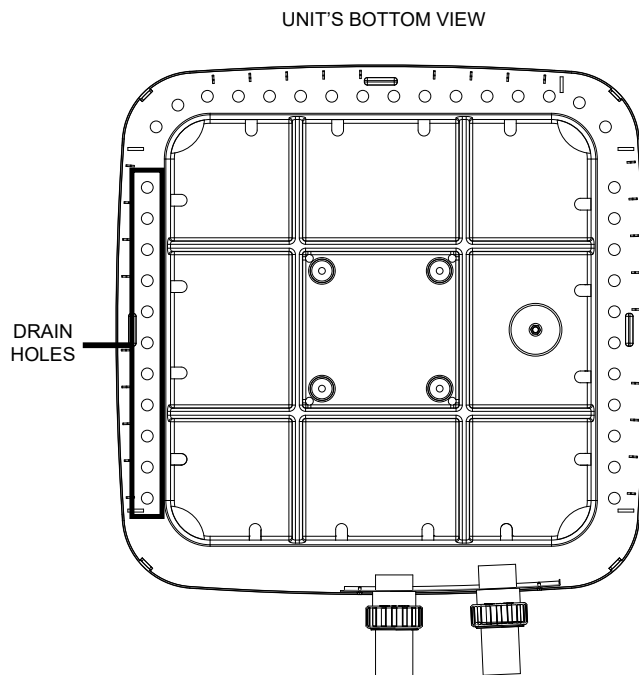



Figure 61. Condensate Drain Hole Locations

## 21. TROUBLESHOOTING

Before troubleshooting the system, ensure that:

- All mechanical and electrical connections are secure and tight
- All system wiring is correct
- Fuse is not blown (3A Automotive “ATO” type fuse for 24VAC)
- That a system ground is properly connected to the heater. Nuisance shutdowns are often caused by a poor or erratic ground.

The service display can be accessed by pressing SERVICE key  .

The service display does not affect operation of the unit which continues to operate in the background. When in this menu, the UP or DOWN buttons will toggle through the various information reported. For more details about Service menu, refer to section 11 "Service Menu", on page 14.

If your unit does not operate, or simply does not heat your pool water, fault messages on the front control panel can provide valuable clues as to what is wrong, and may even indicate precisely what the problem is. Always observe these messages before calling a service representative. By reporting on the telephone the fault messages that are showing, the service representative may be able to solve the problem without the expense of a service call.

### A. Unit Is Running, But Not Heating

- Is water flow through the unit adequate? Check the unit for obstructions, such as a clogged filter pump strainer, a dirty filter, or valves not positioned correctly.
- Is the ejected air from the unit 8°–10°F (4.4°C–5.5°C) cooler than incoming air? If so, the unit is extracting heat from the air and transferring it to the pool.
- Is water condensing on the evaporator and internal copper pipes? This is also evidence of heat removal from the air. When the air is cool with low humidity, condensation may not be evident.
- How long has the unit been operating? During initial pool heating in cold weather, it may require a week to elevate the water temperature to a comfortable level. Normally, it takes about 4-days.
- How many hours per day is the unit operating? **Remember that the heater only operates while the pool pump is running.** Set the time clock to permit 24-hour per day operation. After the desired temperature is reached, return the unit to normal operation of 8–10 hours per day.

- Is airflow through the unit being obstructed? Restrictions such as shrubbery, tall grass, dirty coils, or any other obstruction to airflow will reduce performance.
- Is the pool blanket/cover being used? Uncovered pools can lose up to 10°F (5.5°C) per night compared to 4°F (2.2°C) or fewer when a blanket is used. Without a blanket, the total heat gained during the day can be lost overnight.
- Are rapid heat losses occurring in some other way, such as high-wind, spillage, rainfall, flow through solar panels at night, or a high water table?

**NOTE:** If the heat pump pool heater shuts off before the water temperature is raised to the desired level, you must increase the running time. To do this, reset the time clock dial for a longer running time or manually operate the pump with the timer override switch. Since the unit capacity and efficiency are greater at higher ambient air temperatures, the run time should be set to take advantage of all daylight hours when the air is generally warmer.

### B. Unit Is Not Running

- Is the temperature display ON? If not, the circuit breaker may be shut OFF or tripped. Reset the breaker by switching it OFF, and then back ON. Verify that the breaker is set and operating properly before calling for service.
- Are the Pool/Spa settings correct? Verify that the temperature has been properly set on the thermostat, and that it is higher than the current water temperature.
- Have you waited approximately 3-minutes for the time delay? After the unit has been running and then shut OFF for any reason, there is a delay before operation can begin again. The display will read “Comp Start Delay” when this 3-minute delay is active.

**NOTE:** The heater will not run when the Remote position is selected on the pool/spa control and there is no remote control system attached.

### C. Condensation Seems Excessive

Heat pump pool heaters can produce a large amount of condensation (water) during operation. If you suspect that the unit is leaking:

- Shut the unit OFF and leave the filter pump running to see if the water stops dripping. If the water stops dripping, the unit is not leaking.

**NOTE:** Use a pool chemistry test kit to confirm there is no chlorine in the water.

## 22. SERVICE CALL VERIFICATION

**NOTE:** The Service number is located on the front of the heater at the brand label.

Before you make a service call, **first** determine if the problem is:

- Warranty Service - must have model number, serial number and date of installation or Warranty Registration confirmation number.
- Unit operation (power supply, water flow, or time clock adjustment).

**NOTE:** The manufacturer is not responsible for these adjustments.

### Power Supply

- Verify that all circuit breakers are reset and working properly.
- If the temperature display on the control panel still does not light, contact the installing dealer, since it may be a power problem requiring an electrician.

### Water Flow

- Verify that the pool filter is clean to provide good flow.
- Verify that valves are properly positioned to allow adequate water flow through the unit.

### Time Clock Adjustment

Verify that the time clock is set to permit the unit to run long enough to heat properly.

### Set Factory Defaults

If programming is disarranged and no operation can reliably be made, the control board can be reset to Factory Default values. This operation changes all adjustable settings to factory default settings.

**NOTE:** Previous settings will be erased and are no longer recoverable. All settings will have to be re-entered by hand to re-establish proper operation.

After setting the factory defaults, check the Program, Installer, and Schedule menus as necessary to configure the desired operation settings and optional controls.

## Service Access to Heaters

If service access to the heater is required, it is accomplished by removing the control cover panel and service access panel (Figure 62) to provide a wide access to get to (1) compressor, (2) heat exchanger, (3) thermal expansion valve (TXV), (4) reversing valve/solenoid valve (if equipped), (5) flow switch (if equipped), and (6) sensors (water, ambient and coil). To gain access, follow the steps below:

1. Shut off all power to the unit to avoid any possibility of electrical shock or damage to components.
2. Remove the heater's front control cover panel by unscrewing the six (6) screws using a 1/4" hex head screwdriver. See Figure 62.

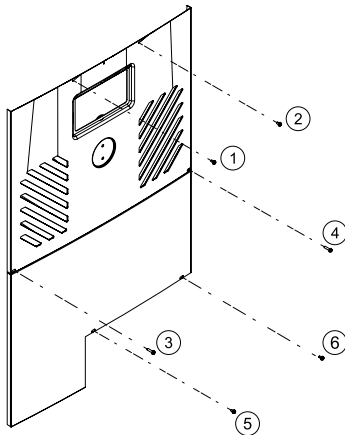

**Figure 62. Sheet Metal Screws to Remove Control Panel**

3. Pull the front panel's bottom down and outward. Disconnect the wire attached to the rear of the user interface. The panel is now free for removal.
4. Set the control panel cover aside to reinstall when service is completed.
5. Install service access panel and slide control cover panel up to its place and secure with screws removed in Step 2.
6. Turn ON power and start operation as needed.

## 23. PLUMBING DIAGRAMS

**NOTE:** Models 4550 – For systems with pumps less than 1-1/2 HP (under 40 GPM / 151 LPM)  
Models 5550-8550 – For systems with pumps less than 2 HP (under 50 GPM / 189 LPM)  
**No external bypass required.**

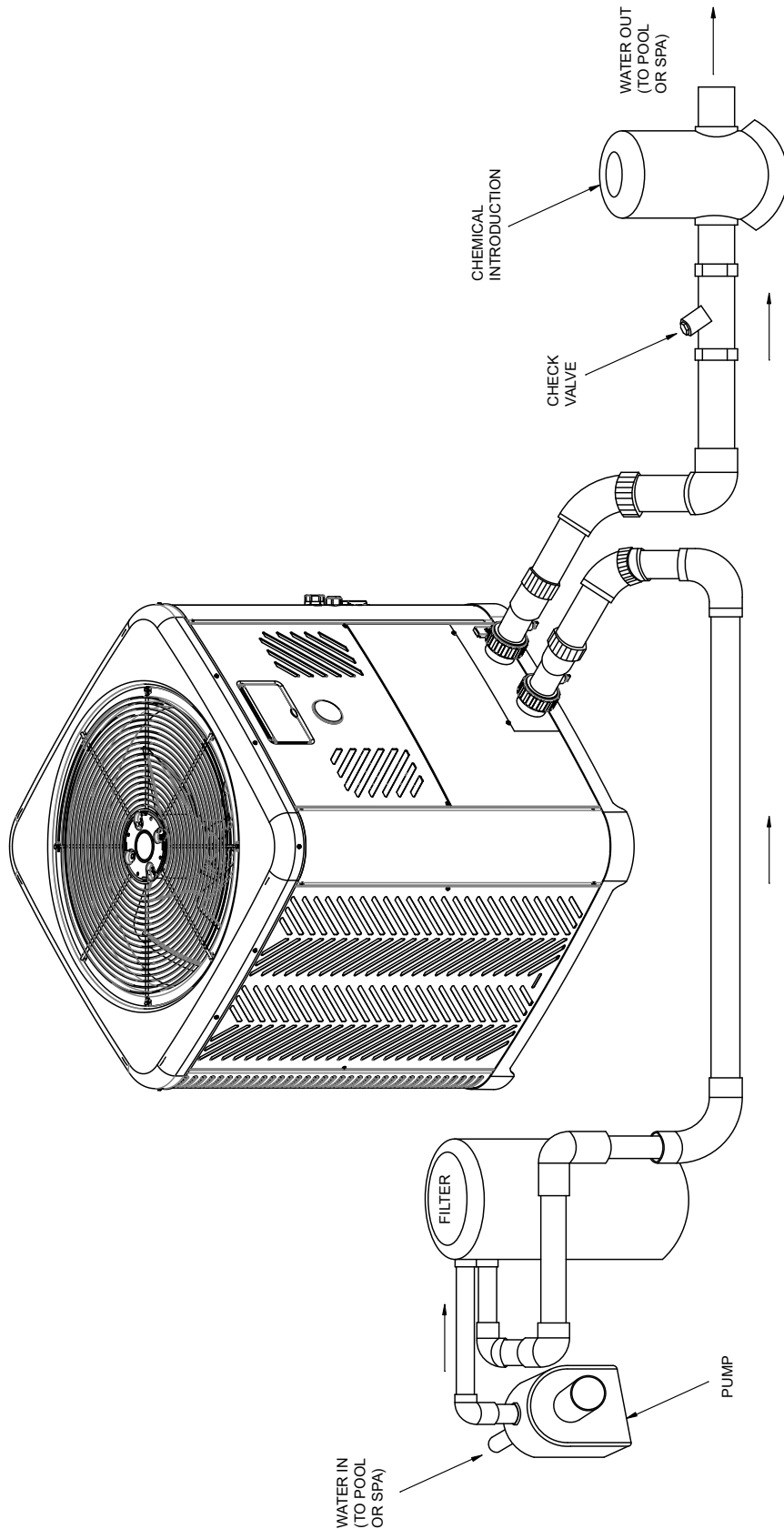

Figure 63. Plumbing Schematic – No External Bypass (Plumb the heater AFTER the filter and before any chlorinators.)

**NOTE:** Models 4550 – For systems with pumps of 1-1/2 HP or greater (over 40 GPM / 151 LPM)  
 Models 5550-8550 – For systems with pumps of 2 HP or greater (over 50 GPM / 189 LPM)  
**External bypass required.**

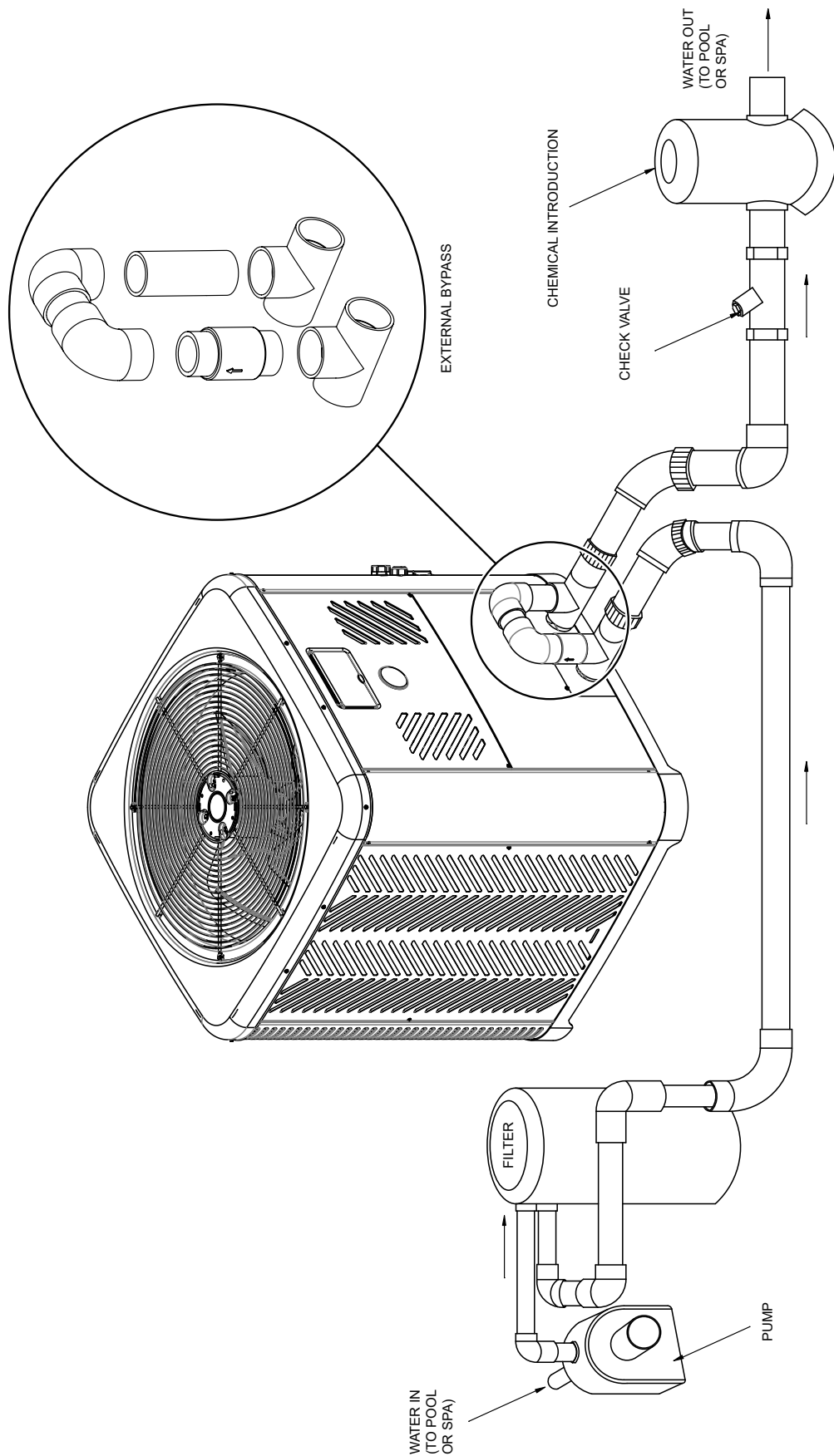

Figure 64. Plumbing Schematic – External Bypass (Plumb the heater AFTER the filter and before any chlorinators.)

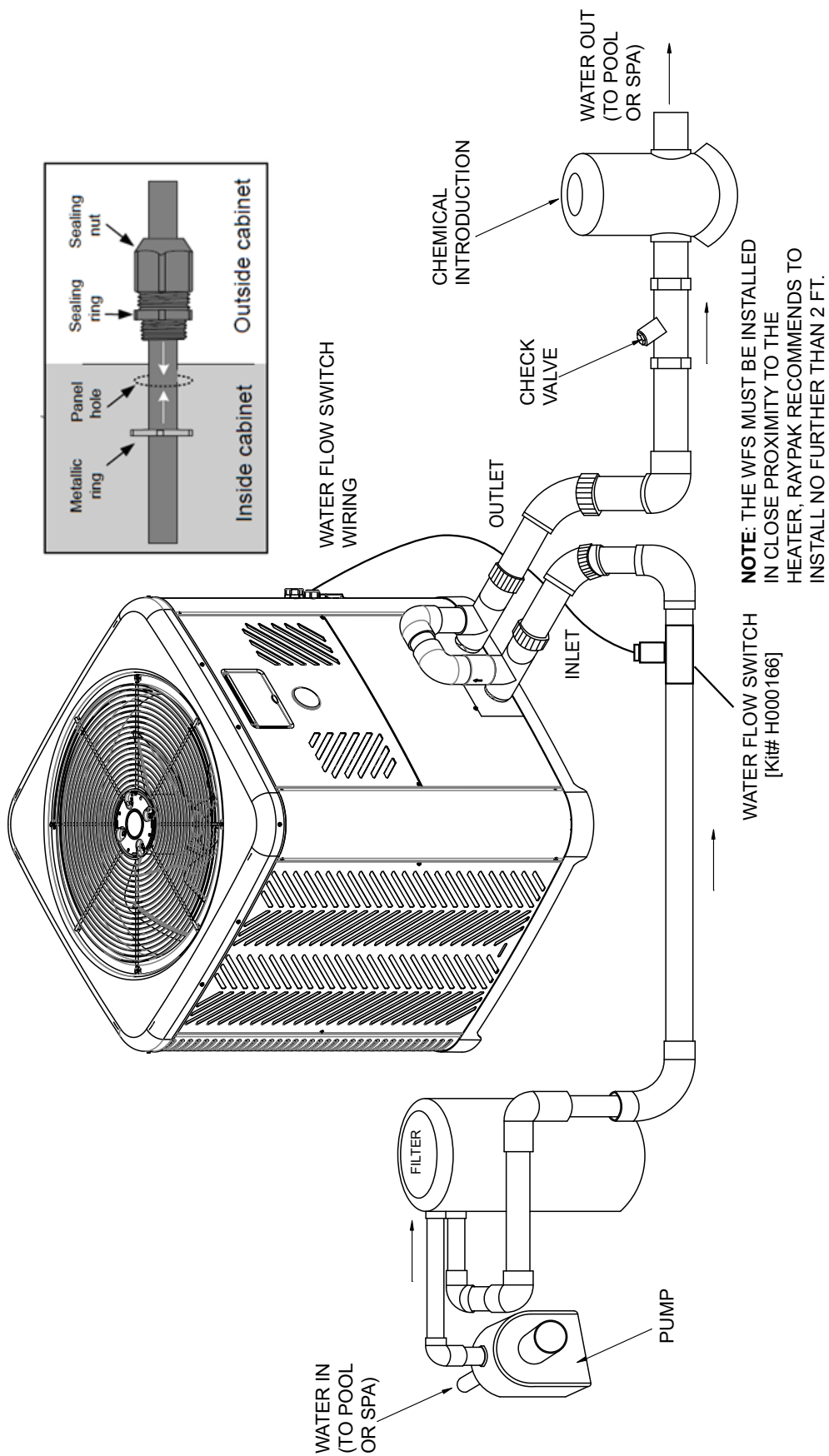
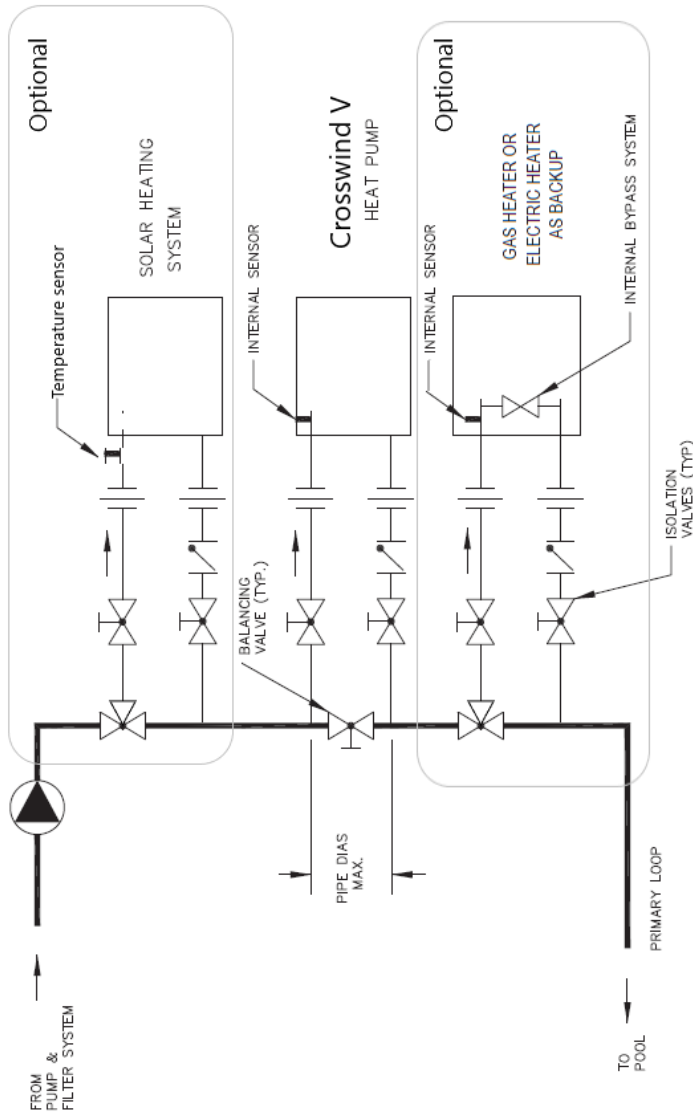

Figure 65. Plumbing Schematic – Above Ground Pool Water Flow Switch Installation



MINIMUM PIPE SIZES	
BRANCH	MAIN
1-1/2"	2"
1-1/2"	2"

THIS PIPING DIAGRAM IS RAYPAK'S RECOMMENDATION AND IS NOT INTENDED TO REPLACE AN ENGINEERED PIPING SYSTEM DESIGNED BY A PROFESSIONAL ENGINEER.



KEY	
	PRESSURE RELIEF VALVE
	PUMP
	UNION
	CHECK VALVE
	BALL VALVE
	THERMOMETER

NOTES:

1. PLUMB SWING CHECK VALVE IN GRAVITY-CLOSED POSITION.
2. PIPE ALL RELIEF VALVES TO DRAIN, OR AS LOCAL CODES REQUIRE.
3. MINIMUM PIPE SIZE MUST BE EQUAL TO THE HEATER INLET/ OUTLET SIZE. SEE "MINIMUM PIPE SIZES" CHART ABOVE.

HEATERS SHOWN REPRESENT VARIOUS MODELS. BECAUSE INDIVIDUAL MODELS WILL VARY IN DESIGN AND SIZING, SEE EACH SPECIFIC HEATER TYPE FOR DETAILS.

4. SOLAR SYSTEM MUST BE INSTALLED IN ACCORDANCE WITH SOLAR SUPPLIER'S INSTRUCTIONS INCLUDING, BUT NOT LIMITED TO, PROTECTION AGAINST OVERHEATING AND/OR FREEZE-UPS.

5. HEAT PUMP MUST BE INSTALLED IN ACCORDANCE WITH SUPPLIER'S INSTRUCTIONS INCLUDING, BUT NOT LIMITED TO, PROTECTION AGAINST OVERHEATING AND/OR FREEZE-UPS.

Figure 66. Piping for Heat Pump Pool Heater

THIS PIPING DIAGRAM IS RAYPAK'S RECOMMENDATION AND IS NOT INTENDED TO REPLACE AN ENGINEERED PIPING SYSTEM DESIGNED BY A PROFESSIONAL ENGINEER.

4550

MINIMUM PIPE SIZES					
2 UNITS		3-4 UNITS		5-6 UNITS	
BRANCH	MAIN	BRANCH	MAIN	BRANCH	MAIN
20 GPM	1-1/2"	1-1/2"	20 GPM	1-1/2"	20 GPM
30	1-1/2"	1-1/2"	30	1-1/2"	30
40	1-1/2"	2"	40	1-1/2"	3
					40
					1-1/2"
					4"

\*Sizing based on 10 ft/sec flow rates

5550-8550

MINIMUM PIPE SIZES					
2 UNITS		3-4 UNITS		5-6 UNITS	
BRANCH	MAIN	BRANCH	MAIN	BRANCH	MAIN
30 GPM	2"	30 GPM	2"	2-1/2"	30 GPM
40	2"	3"	40	2"	4"
60	2"	3"	60	2"	4"
80	2"	4"	80	2"	4"
					80
					2"
					5"

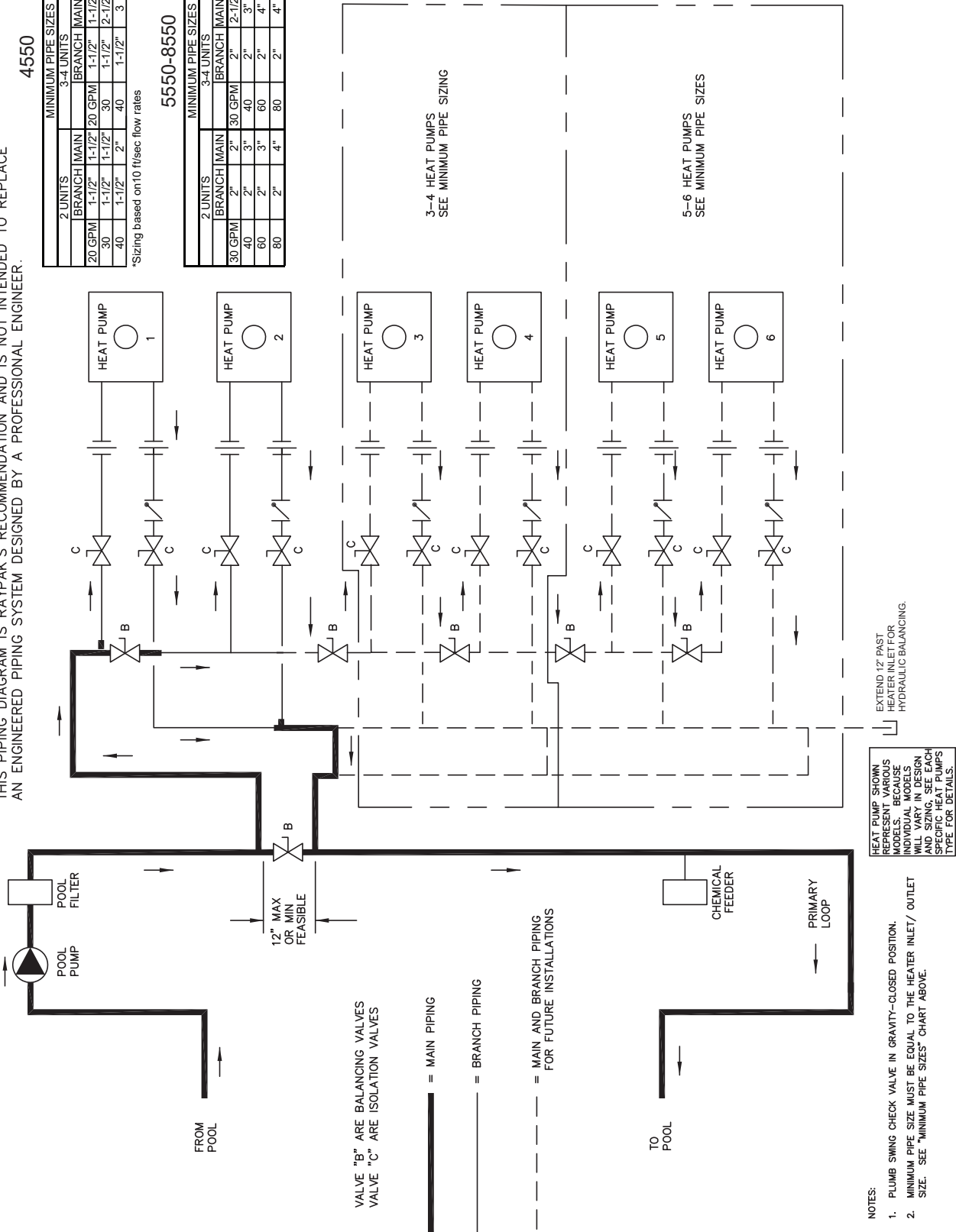

Figure 67. Piping for Multiple Heaters, Primary/Secondary

## 24. RESISTANCE SENSOR VALUES

**Inlet Water Sensor  
100K Sensor Resistance Values**

Temperature °F (°C)	Resistance (Ω)
32 (0)	325500
41 (5)	253950
50 (10)	199040
59 (15)	157150
68 (20)	129440
77 (25)	100000
86 (30)	80570
95 (35)	65310
104 (40)	53260
113 (45)	43680
122 (50)	36020

**Water Outlet, Ambient, Coil and solar sensors  
10K Sensor Resistance Values**

Temperature °F (°C)	Resistance (Ω)
32 (0)	32550
41 (5)	25340
50 (10)	19870
59 (15)	15700
68 (20)	12490
77 (25)	10000
86 (30)	8059
95 (35)	6535
104 (40)	5330
113 (45)	4372
122 (50)	3605

**Table F. Temperature-Resistance Sensor Values**

100KOhm sensors are used for water temperature measurement. These sensors are dual thermistors in a single sensor housing. The control uses both sensor readings in operating the unit. If the control measures temperatures on these thermistors which are approximately 3°F (1.6°C) apart, the control will shut off the compressor and show "In Sensor Fault".

The message will be cleared and operation resume when thermistors are within 2°F (1.1°C) of each other. The sensor has a measurement error of less than +/- 0.5°F (0.3°C) between 36°F and 110°F (2.2°C and 43°C) temperatures. The control displays 100K sensor temperatures to 0.1°F or 0.1°C resolution. The water temperature used for thermostat decisions is the average of the 2 thermistors.

10KOhm sensors are used for the Outlet water temperature, Ambient Air Temperature sensor, the Coil Temperature sensor. Additionally, the control board Solar sensor terminal is designed for a 10KOhm Temperature sensor (field-supplied when necessary). The sensor has a measurement error of less than +/- 0.5°F (0.3°C) between 36°F and 110°F (2.2°C and 43°C) temperatures. The control displays 10K sensor temperatures to 0.1°F or 0.1°C resolution.

## 25. CONNECT TO WI-FI WITH RAYMOTE

Before initiating the provisioning process, make sure a reliable Wi-Fi access point is located near the unit or control room and a Wi-Fi network password is available.

Date: _____
Wi-Fi Network Name (SSID): _____
Wi-Fi Password: _____

### Raymote User Registration

Download Raymote app and sign up from your mobile device. Use your email to create a new account. You'll receive an email confirmation. See Figure 68.

**NOTE:** Check your email spam if you do not receive an email within 5-minutes in your inbox.

Use your email address as the Raymote user, then create a secure password. See Figure 69.

Once the user registration is complete, you can begin to add your Crosswind V heaters via the Raymote mobile app.

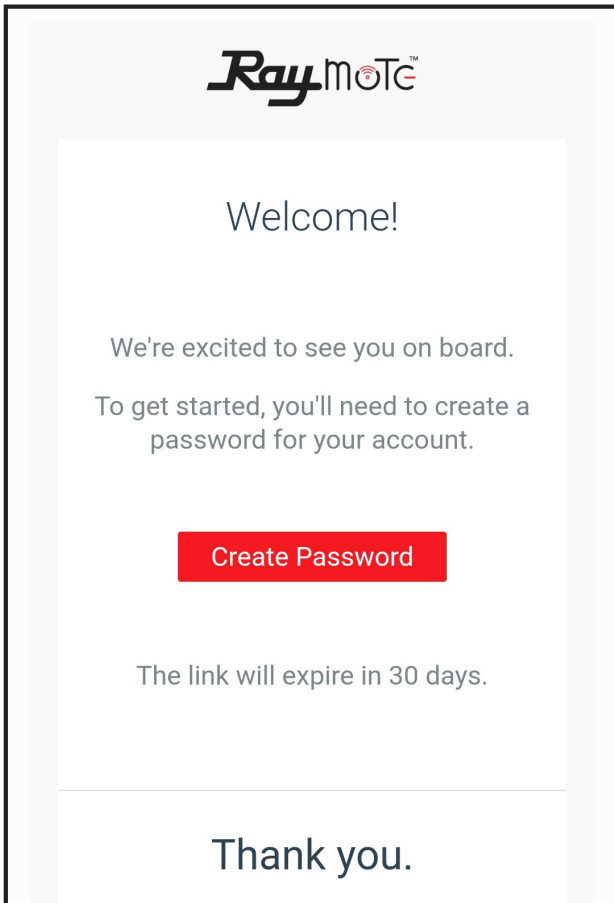

Figure 68. Welcome Raypak Dashboard

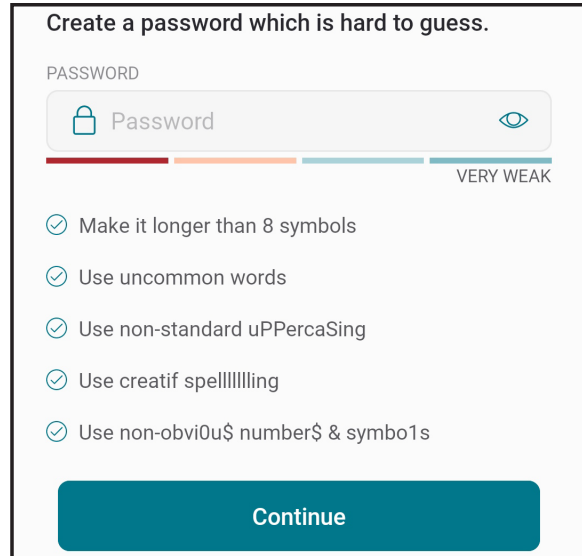

Figure 69. Create Password

### Downloading the Raymote Mobile App

1. Download and install the Raymote mobile app from the Google Play ([Android](#)), or App Store ([iOS](#)), on your mobile device.
2. Find the Raymote mobile app icon on your device. See Figure 70.

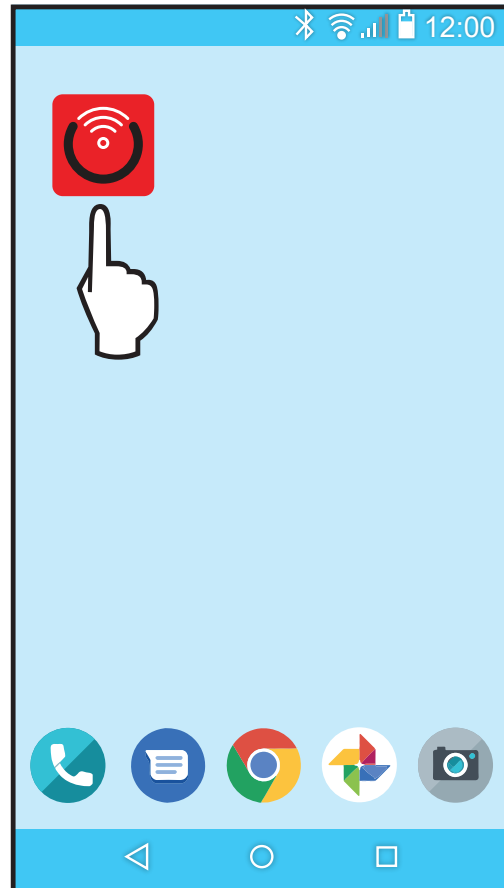

Figure 70. Find your Raymote Mobile App Icon

- Open the Raymote mobile app and log in with your user name and password. See Figure 71.

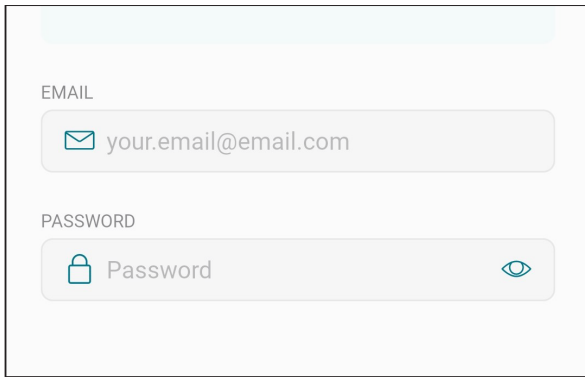

Figure 71. Log in the Raymote Mobile App

## Preparing the Unit for Connection

- Stand near the display of the Crosswind V unit. Press the CONNECT key. See Figure 72.

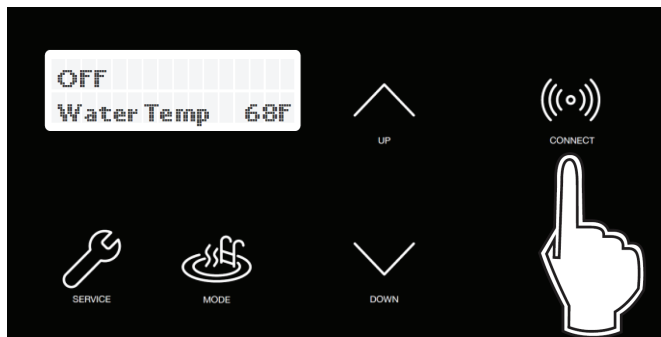

Figure 72. CONNECT Key

- The CONNECT menu displays the Wi-Fi State, indicating "Ready to Config" wireless connection, and also the HOTSPOT identifier. See Figure 73.

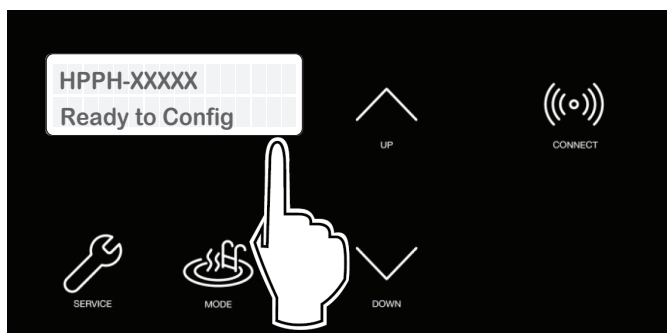



Figure 73. Wi-Fi Ready to Configure and HOTSPOT Identifier

- At this point your unit is ready for connection.

**NOTE:** The following sections provide the instructions for Android and iPhone devices.

## Add a New Heater to Raymote

- In the Raymote app, press the menu button  located at the top left corner of the screen, then press "+ Add new device". See Figure 74.

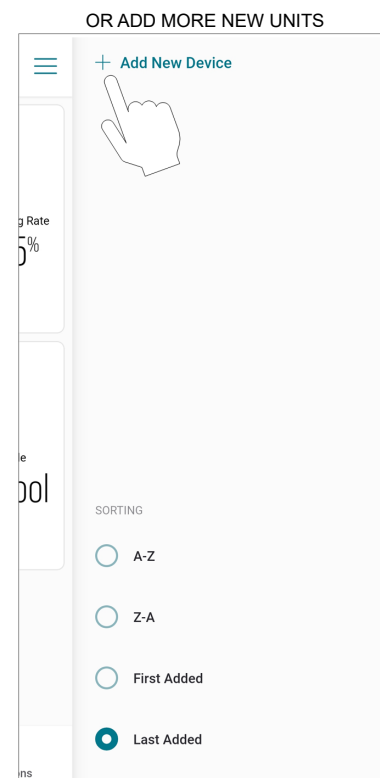
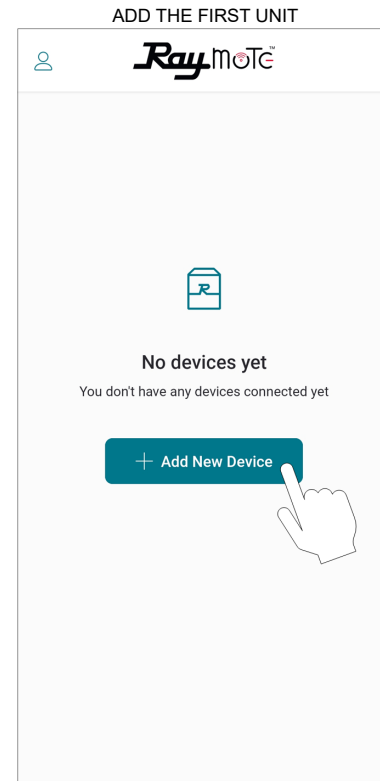
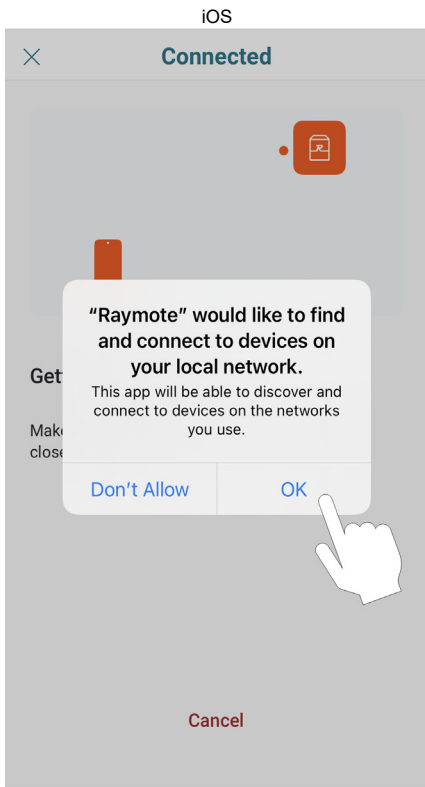

Figure 74. Add New Device

**NOTE:** The first time you use a new phone, the Raymote mobile app may require you grant permission to access data. See Figure 75.

2. "Check your Device" screen will appear. Ensure to have Crosswind V heater powered and Wi-Fi signal available in the area, then press "Start" button. See Figure 76.



ANDROID

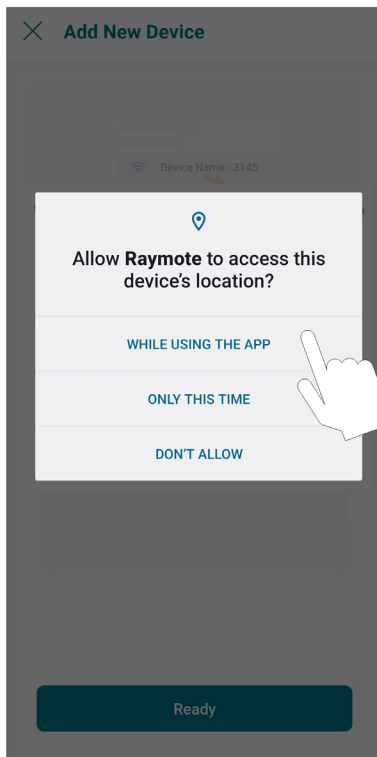

Figure 75. Grant Permission

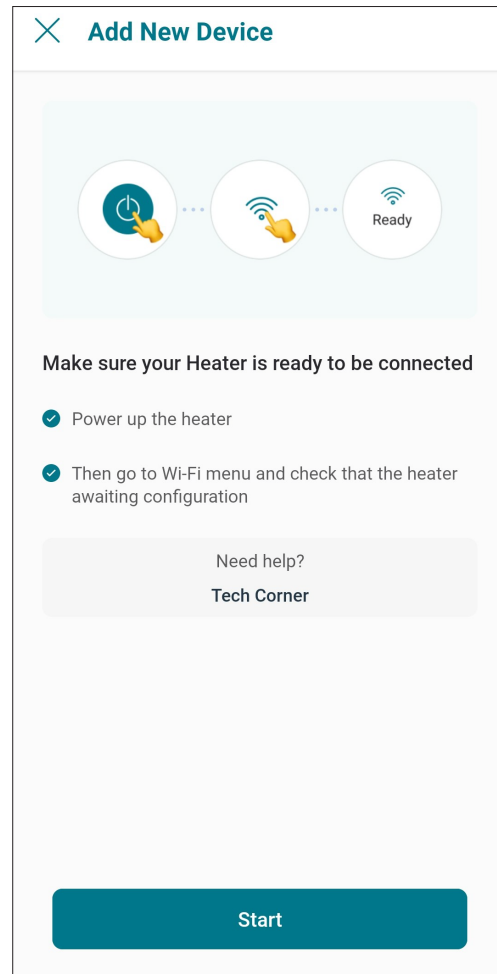

Figure 76. Check your Device

3. **In Android:** Depending on your configuration, one or more devices will appear on the app. Select the HOTSPOT identifier that matches the unit's display as shown in Figure 77.

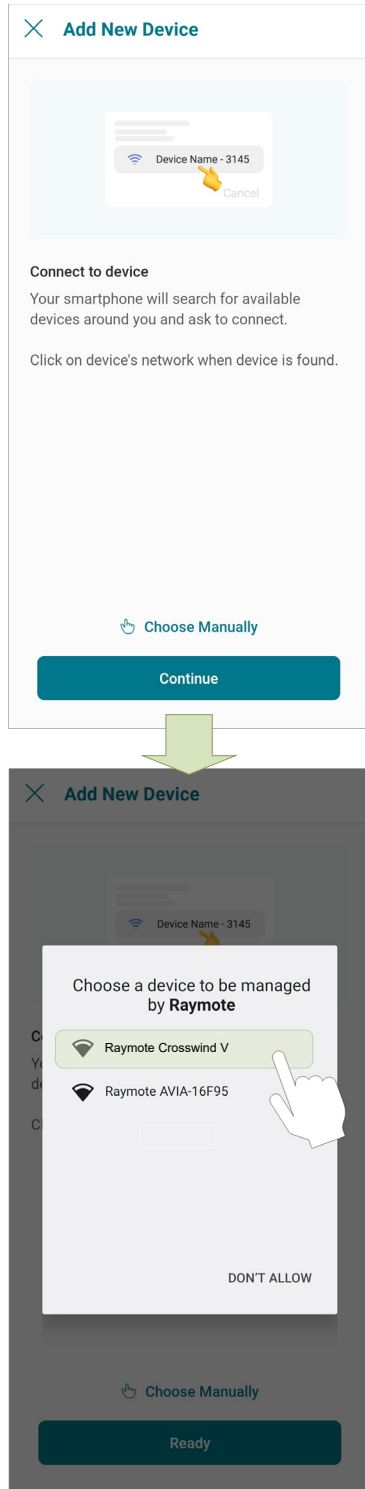

Figure 77. Connect with Android Smart Phone

4. **In iPhone:** Raymote app will start to scan nearby heaters. If you have multiple units ready to connect, stand closer to the unit you want to connect first. Press "Join" to select the displayed heater that matches the HOTSPOT identifier, or press "Cancel" to start the process again. See Figure 78.

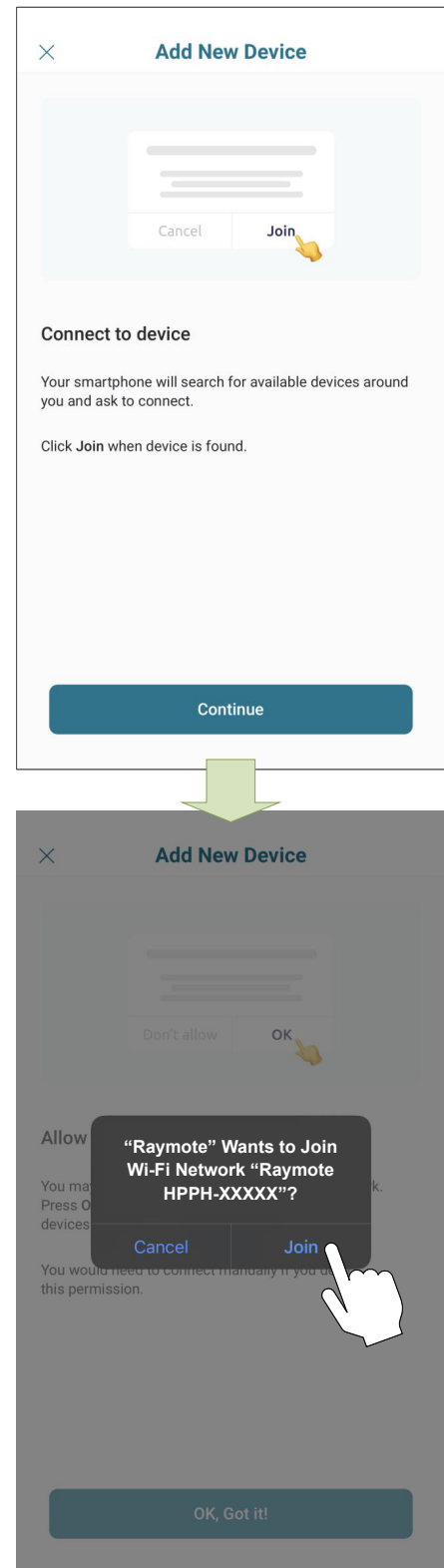

Figure 78. Connecting with iPhone

- The "Wi-Fi setup" screen will appear. Select or enter the Wi-Fi network you want your unit to be connected to and enter the network password. See Figure 79.
- Press the "Continue" button to proceed with unit connection.

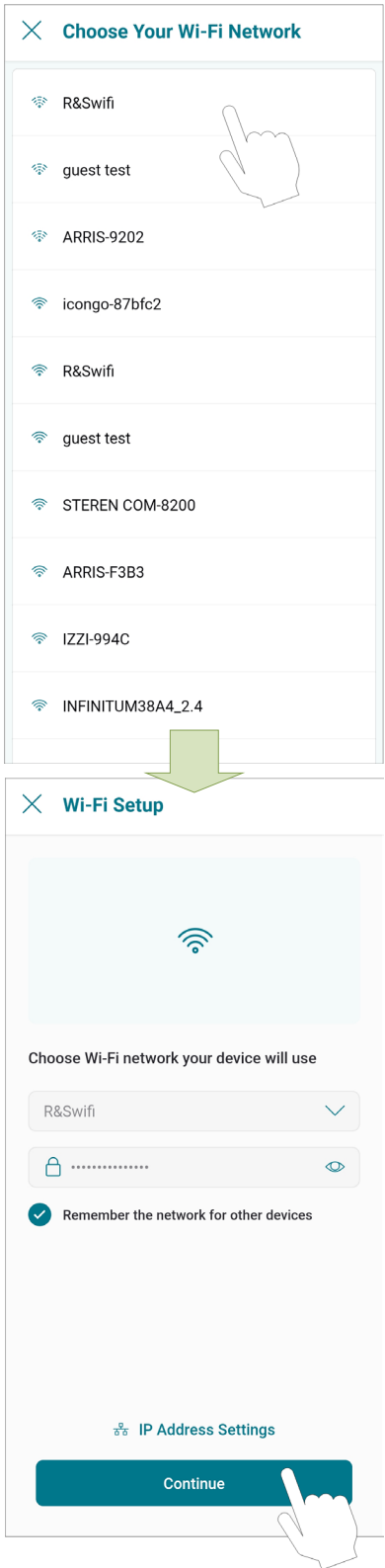

Figure 79. Wi-Fi Setup

**IMPORTANT:** Raymote Wi-Fi module works with 2.4GHz Wi-Fi signals only.

Ensure to have a strong signal near the heater, the Wi-Fi password and to use a 2.4 GHz network.

(IEEE 802.11, 802.11b/g/n/ax).

- Raymote app will provide the Wi-Fi credentials to your unit. This process may take a few seconds. See Figure 80.

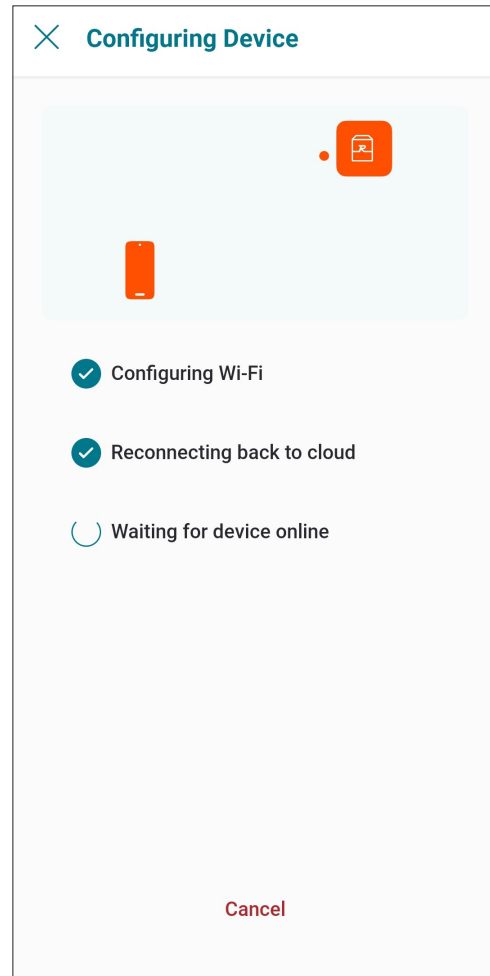

Figure 80. Configuring Device

- Continue on page 49 to setup Crosswind V Heater.



## Crosswind V Heater Setup

1. Your device is now connected to Wi-Fi. You can change the name of your device here. See Figure 81.

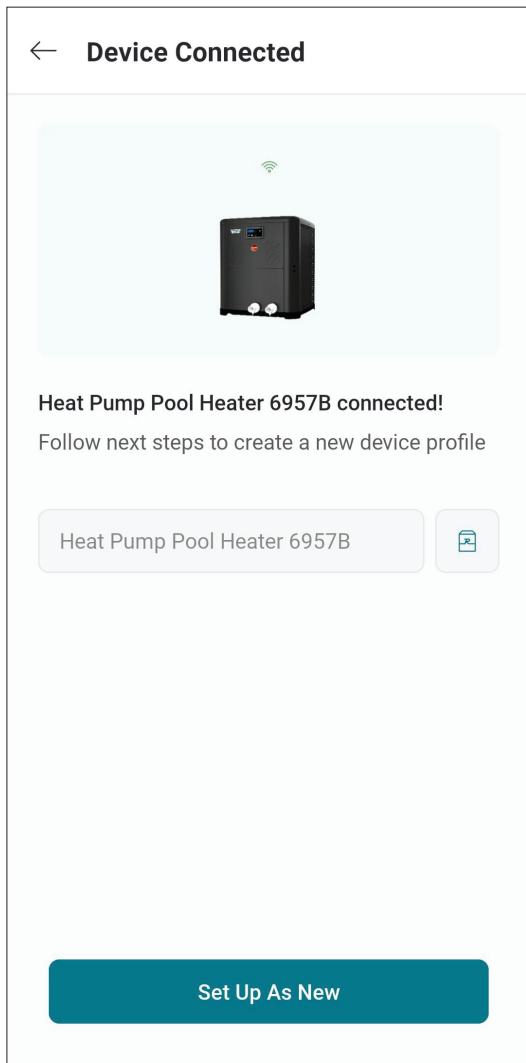

Figure 81. Name Your Unit

2. Press the "Set up as new" button to enter heater location, and other helpful info for future references. Press the "Apply recently used profile" button to use information previously applied to other heaters.
3. During device configuration, basic reference information about the heater will be requested, including service provider, site location, Pool and Spa size. See Figure 82.

**NOTE:** This information can be added at any time from the Raymote mobile app. It is strongly recommended to make sure this information is completed.

4. After completing the Raymote configuration, the unit will start broadcasting data to the Raymote cloud.

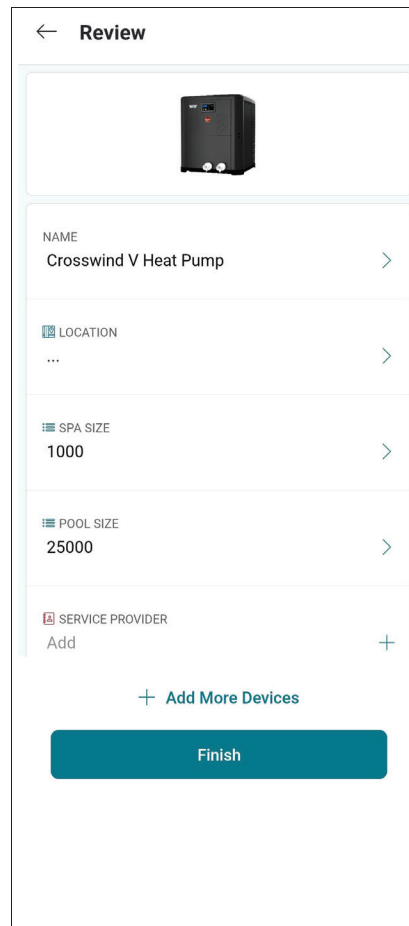

Figure 82. Device Setup Review

## 26. RAYMOTE MOBILE APP



### User and Organization Settings

1. User profile:
  - Update your username, email, or password.
  - Edit or delete your Raymote account.
2. Raymote App settings:
  - Adjust app preferences for notifications and appearance.
3. Organization Settings:
  - Review and Update your Raymote organization settings.
  - Add, edit, or remove Members with access to your Raymote organization.
  - For Raymote client accounts, share access to your Raymote organization with a Contractor with an active Raymote Partner account.

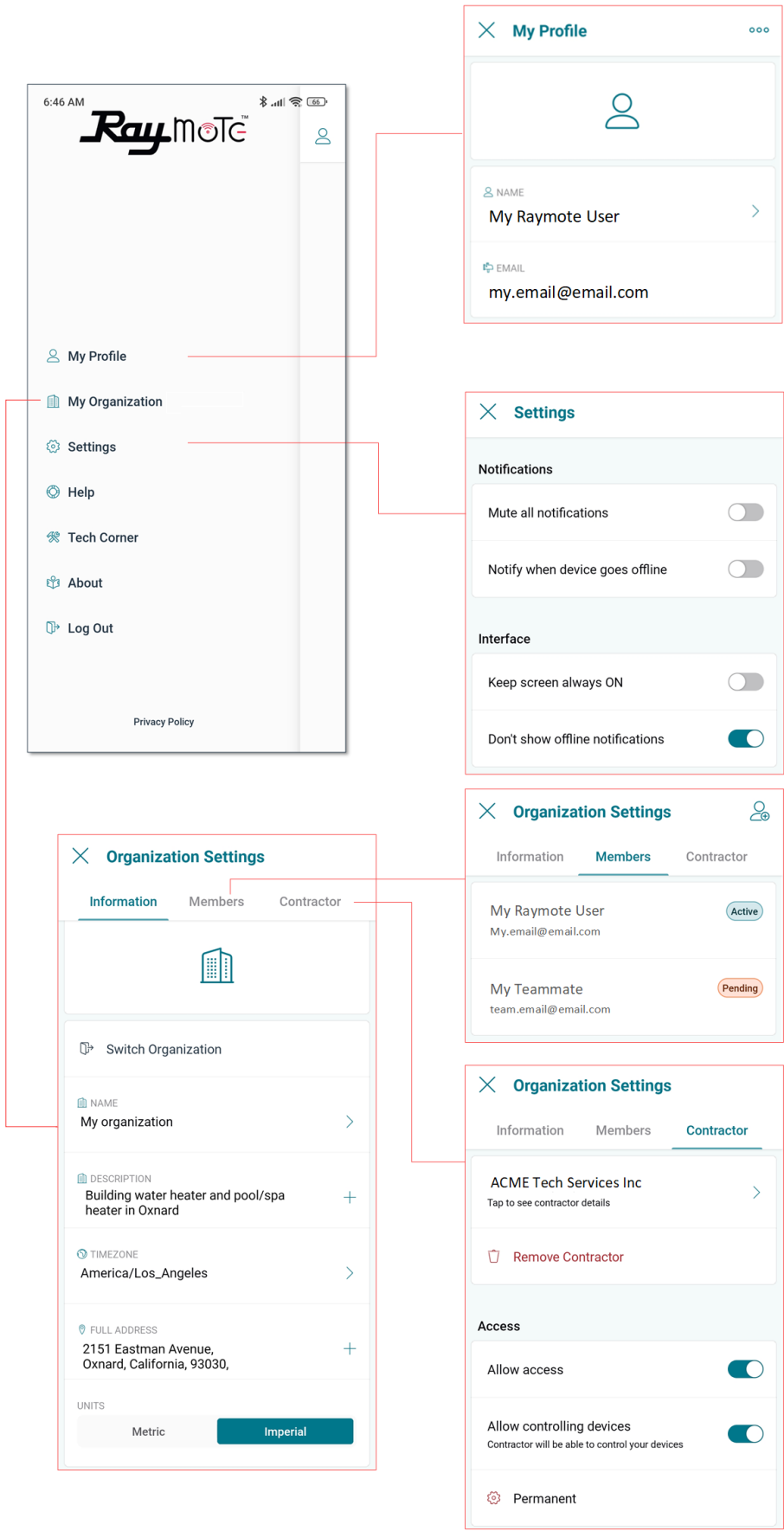

Figure 83. Settings - Client Accounts

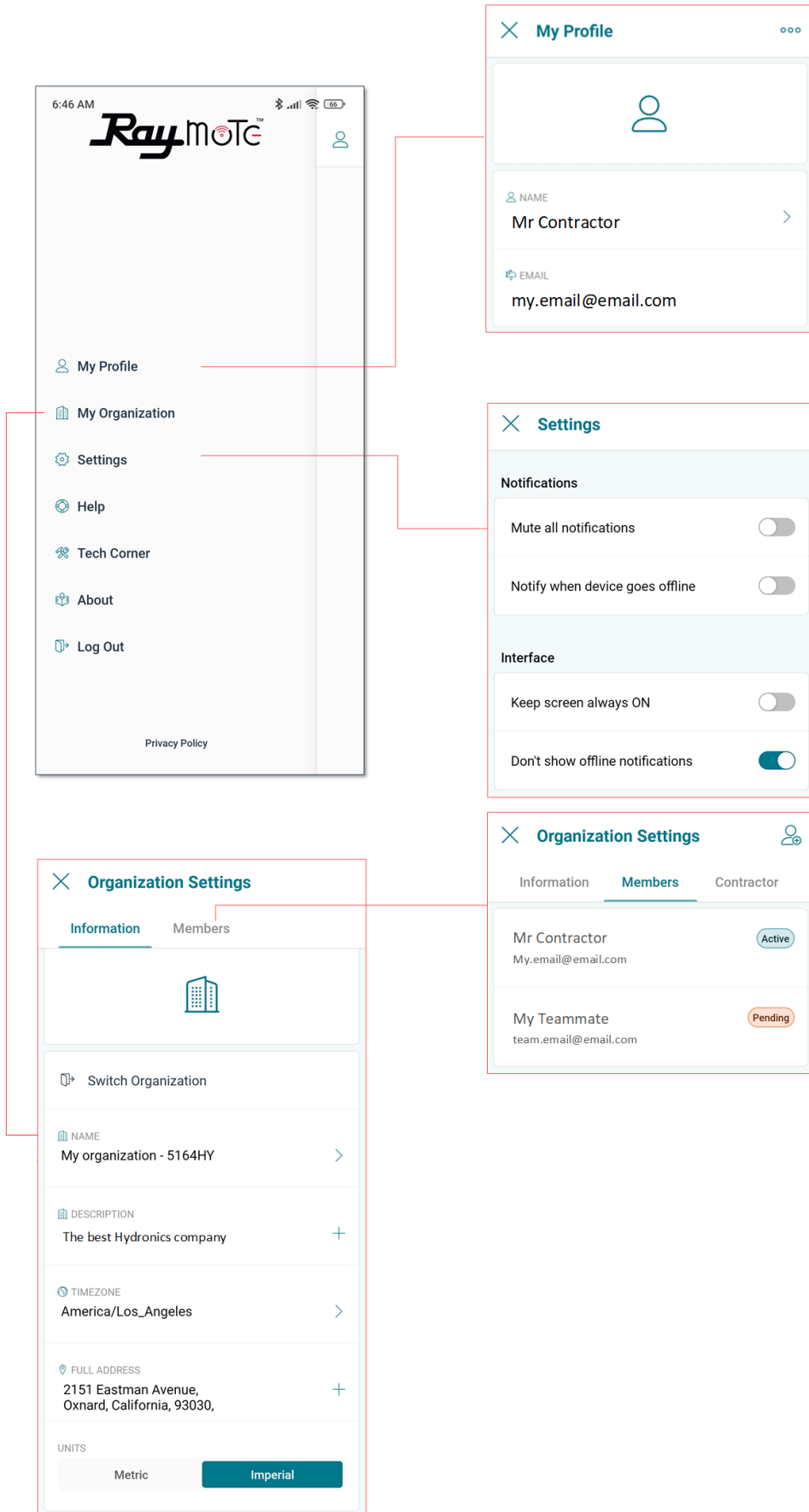

Figure 84. Settings - Partner Accounts

## Help and Tech Support

Raymote app provides direct access to technical support for Raypak heaters, service kits, I&O manuals and Raymote topics:

1. Raymote Help:
  - In-App access to Raymote Online resources and technical contents.

2. Tech Corner:
  - In-App access to Raypak Tech Corner collection. You can find here detailed instructions for Raypak products and service kits. See Figure 85.

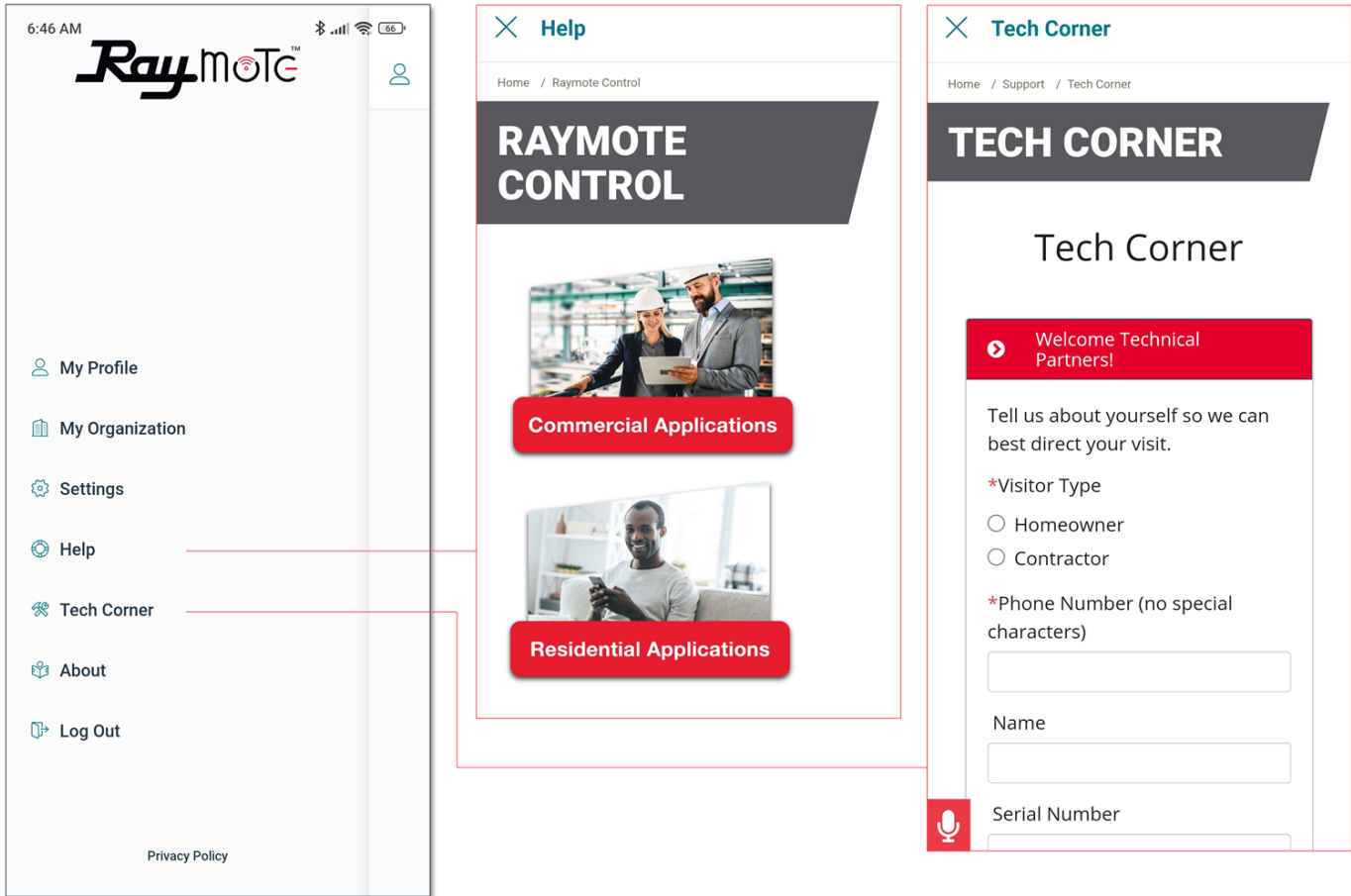

Figure 85. Help and Tech Support

## Main View

- The main view of Raymote display a list of the heaters added in to your Raymote Organization.
- Each heater is represented by a tile with its name and an overview of the heater operation parameters.

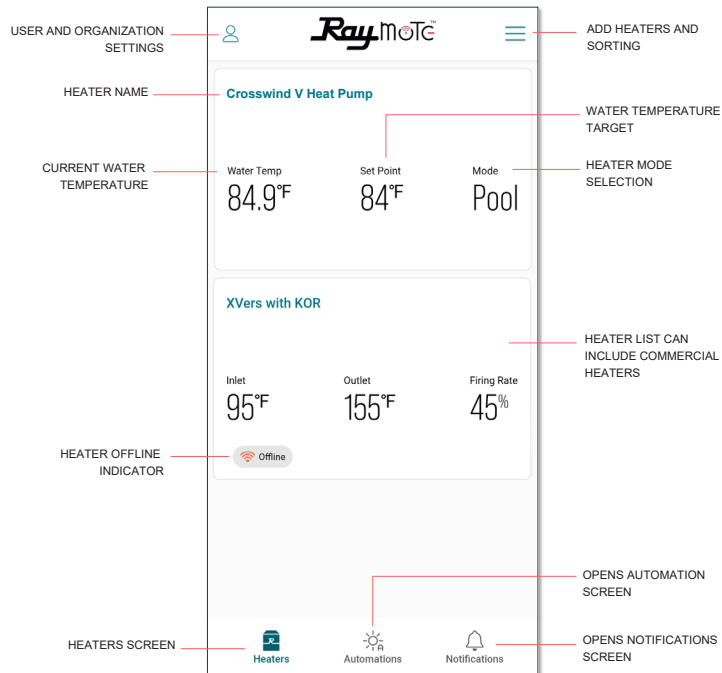

Figure 86. Main View - Heaters List

### Heater Name

- Heater name is defined during the heater connection and setup, but it can be changed anytime from the heater settings.

### Water Temp

- The water temperature measured by the heater is displayed in this field. Water Temp varies with the ambient temperature, pumps and heater's operation.

### Setpoint

- Setpoint is the goal temperature for the heater. It can be adjusted from the Crosswind V control board or directly from Raymote.
- Heater start a call-for-heat when Water Temp is 1 degree Fahrenheit or more, below the setpoint and operation Mode is POOL or SPA.
- In heat/cool models, Pool cool mode, heater starts to cool when water is 1°F above temperature setpoint.
- In heat/cool models, Pool auto mode, heater starts to cool when water temp is above temperature setpoint + cooling deadband. In this mode, unit call-for-heat if water temperature is 1°F below temperature setpoint.

- Heater terminates heat when Water Temp is equal or greater the setpoint temperature, or when Mode is changed to OFF.

### Mode

- Mode field displays the current operation mode selected.
- POOL mode use an independent setpoint. Heat/Cool models include POOL COOL and POOL AUTO modes.
- SPA and TIMED SPA modes use an independent setpoint.
- In OFF mode the heater is operational but is maintained in standby until mode changes to POOL or SPA.

### Offline Indicator

- The offline indicator is displayed only when the heater can not be detected online.
- Offline status can be cause by a heater disconnected from power, Wi-Fi signal weak or not available, or due to any change in Wi-Fi signal name or password.
- Check the Connectivity Troubleshooting section for details on how to recover or reconnect a heater to Raymote.

# Automation

Raymote automation offers the ability to create automatic routines to control the heater and compatible devices like pumps and valve actuators. For details about compatible devices refer to section 27, "Optional Control Outputs", on page 72. See Figure 87 and Figure 88.

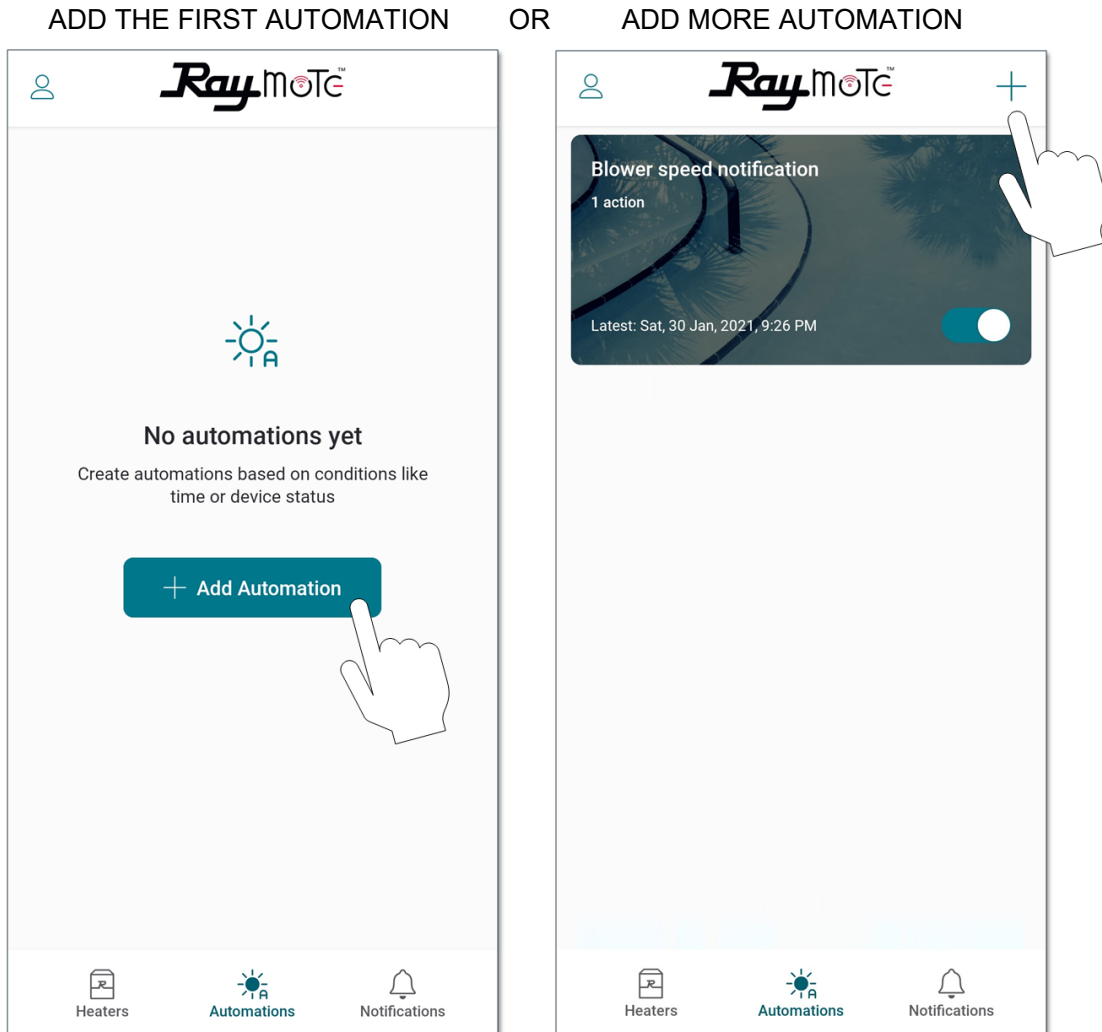
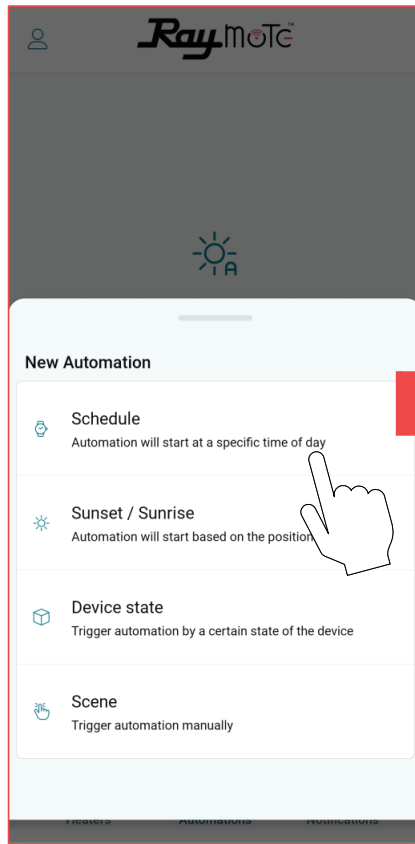
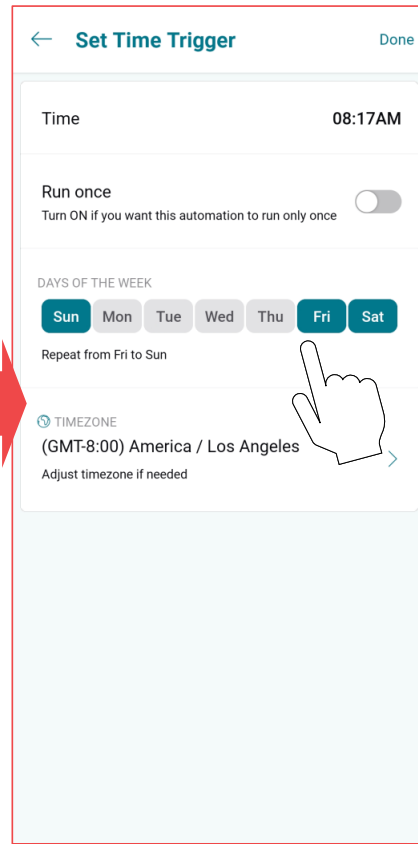

Figure 87. Automation

### SELECT A TRIGGER



### CONFIGURE TRIGGERING



### SELECT AN ACTION

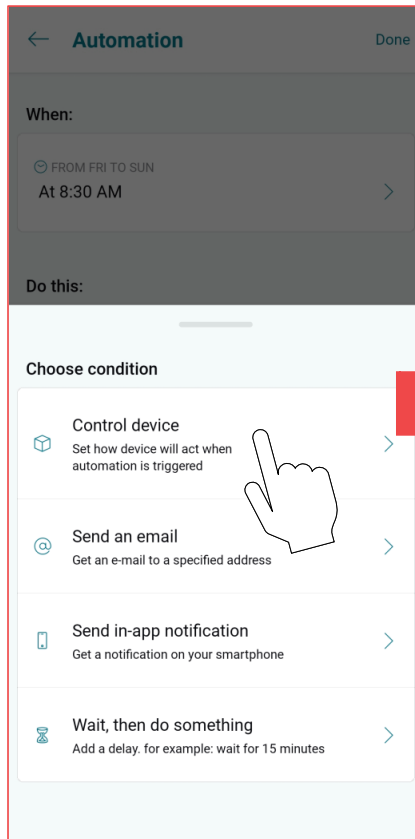

### CONFIGURE THE ACTION

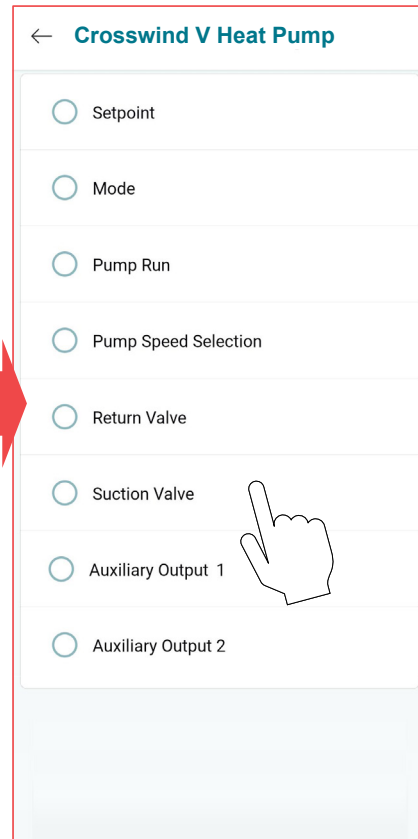

Figure 88. Set New Automation

# Pool-Spa Screen

The Mode Screen contains the main controls for the heater. Operation mode and setpoint can be selected from this screen.

This screen also provides the water temperature sensed by the heater, as well as its current operation status. See Figure 89.

**NOTE:** When OFF is selected, the setpoint slider is disabled.

**NOTE:** When unit is controlled with remote mode, the buttons OFF, Pool and Spa are disabled in the App.

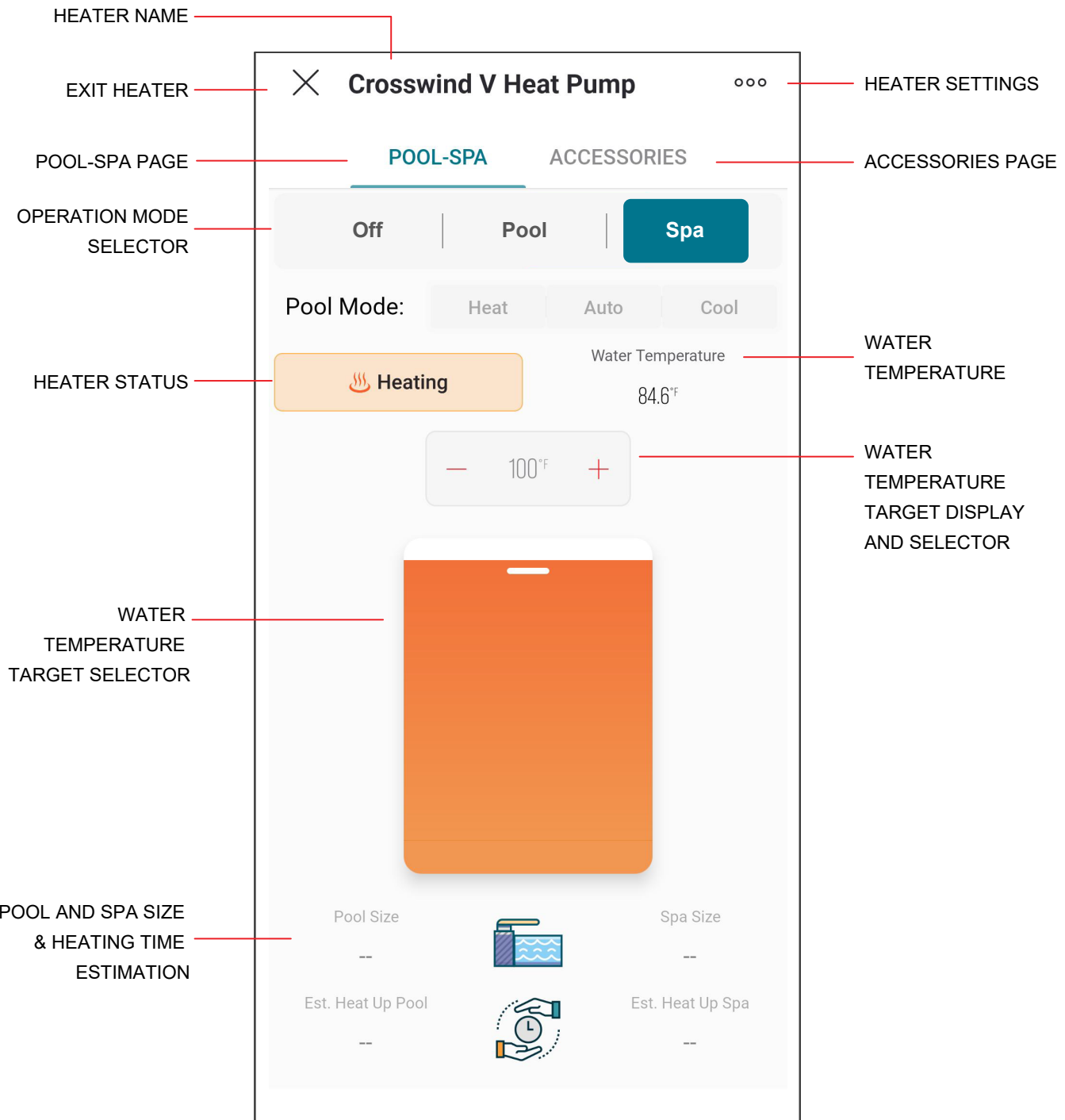

Figure 89. Crosswind V Controls



### **Heater Name**

- Heater name is defined during the heater connection and setup. It can be changed anytime from the heater settings.

### **Exit Heater**

- Press X to close heater view and return to heater's list.

### **Heater Settings**

- The 3-dot icon opens heater settings.
- Use this option to edit the parameters defined during heater configuration.

### **POOL-SPA page**

- Displays the page to control the operation mode and water temperature target.

### **ACCESSORIES page**

- Displays the page to control heater accessories.

### **Operation Mode selector**

- This 3-button selector can be used to change the operation mode in the heater.
- Use OFF option to stop heating. In this mode the heater is operational but is maintained in standby until mode changes to POOL or SPA.
- Use POOL or SPA mode to set a water temperature target.
- POOL and SPA mode use an independent temperature target for each mode.
- Pool mode selector is enabled in Heat/Cool models.

### **Heater Status**

- This display shows the current operational status of heater.
- No Demand is displayed when the unit is in OFF mode or when Water Temperature is equal or above the temperature target.
- Heating is displayed when the unit is heating. In Heat/Cool models, Cooling is displayed when pool cool or pool auto is selected and the unit is cooling.

### **Water Temperature**

- The water temperature measured by the heater is displayed in this field.

### **Setpoint or Target Temperature**

- The water temperature setpoint display and selector shows the water temperature target.
- Heater start to heat when Water Temperature is 1 degree Fahrenheit or more, below the setpoint and operation Mode is POOL or SPA.
- Heat/Cool models, Pool Cool mode: Heater starts to cool when water temperature is 1F or more above the setpoint.
- Heat/cool models, Pool Auto mode: Heater starts to cool when water temperature is above the temperature setpoint + cooling deadband. Heater start to heat when Water Temperature is 1 degree Fahrenheit or more, below the setpoint

### **Setpoint slider selector**

- The setpoint slider can be used to make quick changes to the water temperature target.
- Selection can be fine-tuned with the [+] and [-] buttons in the setpoint display and selector.

### **Pool and Spa size**

- The Pool and Spa size displays shows the size selected in the configuration of the heater when connected to Raymote.
- These parameters can be updated from the Heater Settings page.

### **Pool and Spa estimated Heat up time**

- These fields displays an estimated heat up time based in the provided Pool and Spa size, the current water temperature, the water target temperature and ambient temperature.
- Technical restrictions apply to this estimation.

## Accessories Screen

The accessories screen includes the auxiliary and extended heater controls in the Raymote mobile app. These controls allow users to command an Auxiliary relay that can be wired to turn on and off a pump, lights or water features.

This screen also provides control to Raypak Protege variable-speed pump when connected to the heater. See Figure 90.

**⚠ WARNING:** Only authorized users have access to remotely control the heater, do not provide access to unauthorized users.

**NOTE:** Check Section 27 "External Control Outputs" section for details of wiring and rating of the built-in auxiliary relay.

Some controls are application dependent and may not be available on all units. When a control or set of controls are not available, these will be grayed out.

Raymote controls will reflect the actual status of the value on the local unit. When a change is applied to any control item, the position of the selector will reflect the confirmation value of the setting. See Figure 90.

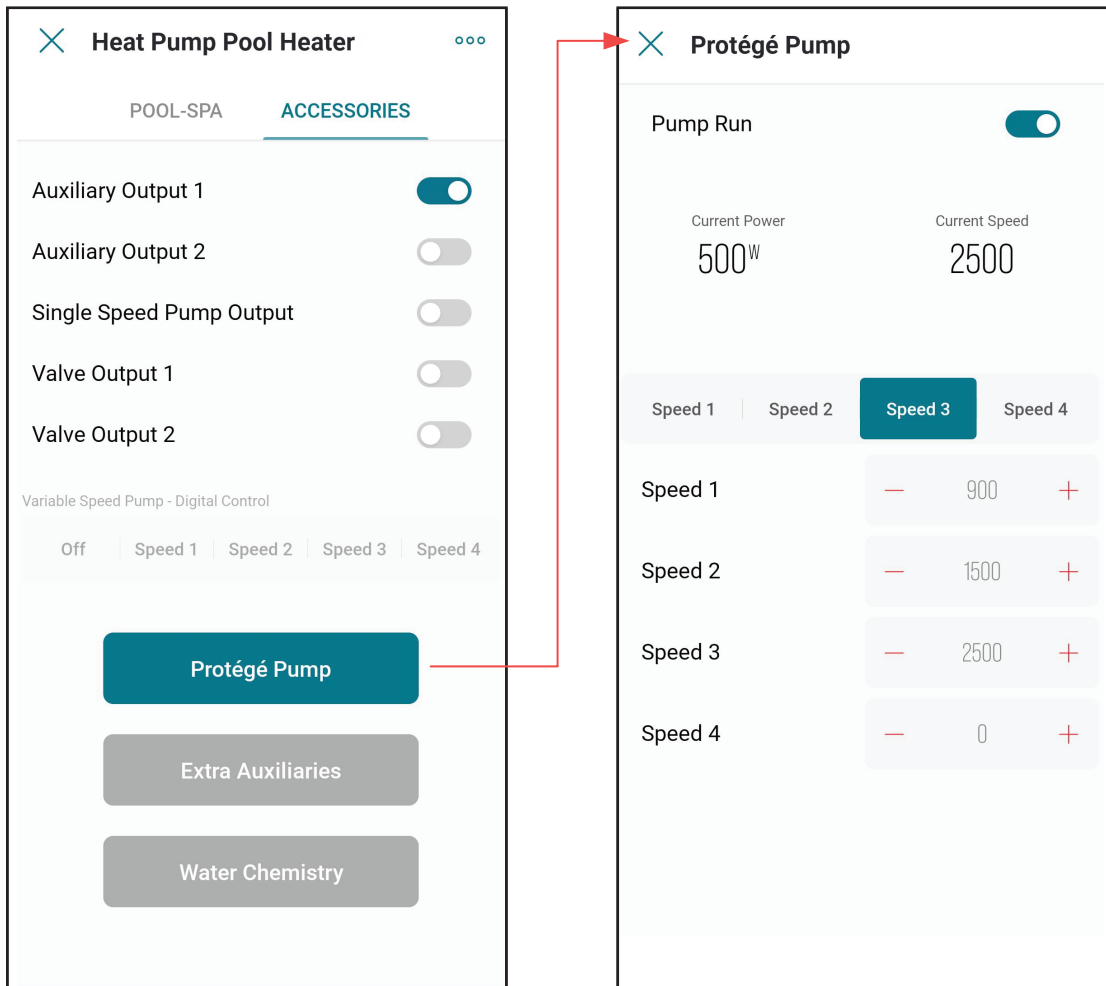

Figure 90. Crosswind V Accessories

**NOTE:** Use your smartphone camera to open QR link below to access the latest instructions and detailed technical support for Raymote and Crosswind V: <https://www.raypak.com/support/tech-corner/raymote/>



## Reset Wi-Fi Credentials

Resetting the Wi-Fi is useful when the heater is trying to connect to a Wi-Fi signal that is not available or has been changed. See Figure 91 through Figure 94.

**NOTE:** After resetting Wi-Fi credentials, the heater needs to be manually connected again to Wi-Fi to work with Raymote features. Ensure to reconnect as existing unit in Raymote app or add it as a new device.

1. Press and hold the CONNECT key for 5-seconds.

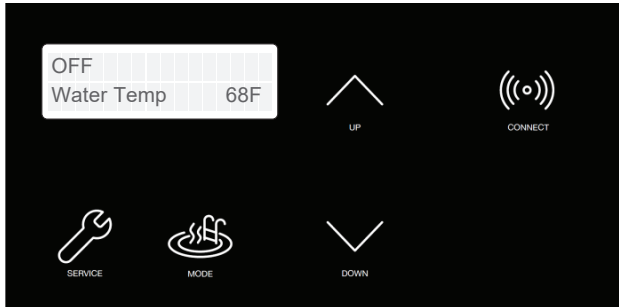

Figure 91. Wi-Fi Reset – Press and Hold CONNECT

2. The display shows “Reset Wi-Fi?” In the top row and “No” in the second row.
3. To cancel and exit, press MODE.

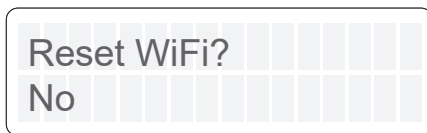

Figure 92. Wi-Fi Reset Menu

4. To proceed with reset, press UP key.
5. Second row now shows “Yes”.

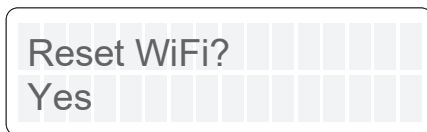

Figure 93. Wi-Fi Reset Confirmation

6. Now press Mode key to reset.
7. “Wi-Fi Initialized” message is displayed.

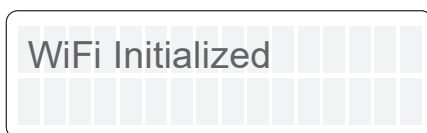

Figure 94. Wi-Fi Reset Completed

8. Now connect again or re-configure an existing heater.

## Reconnect to Wi-Fi

Follow the next steps to reconnect a heater already registered in Raymote, to a new Wi-Fi network or after a change of Wi-Fi password.

1. Select the device that needs to be reconfigured.
2. Press the 3-dots button on top-right corner to open unit settings. See Figure 95.

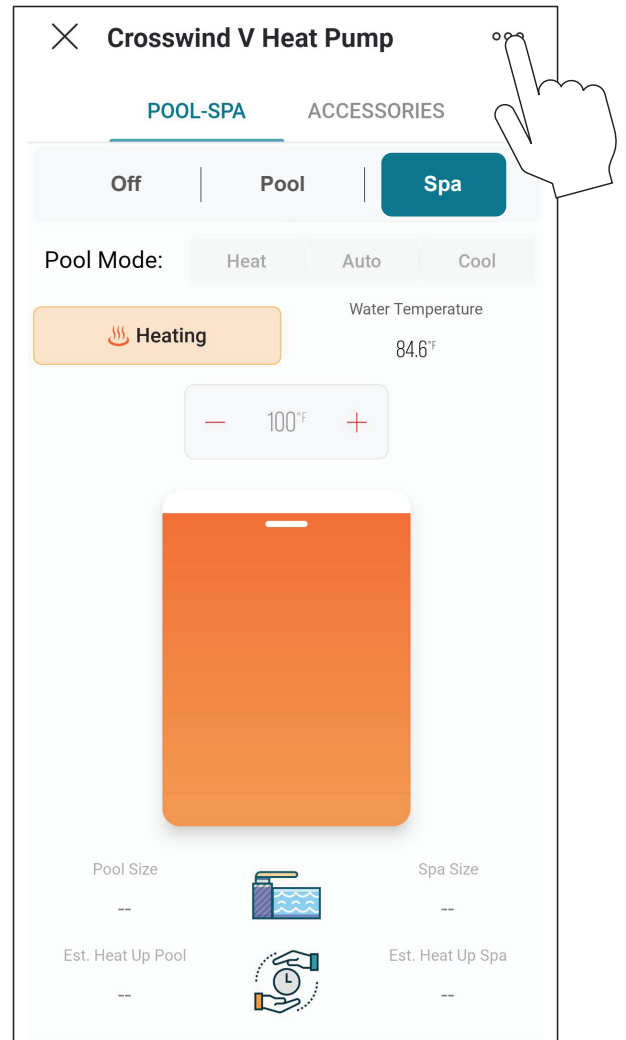
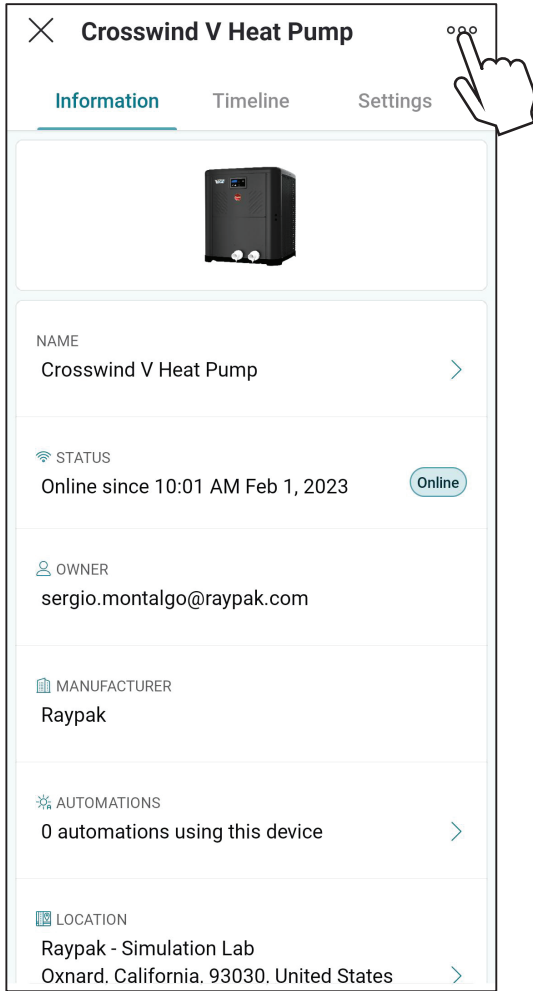
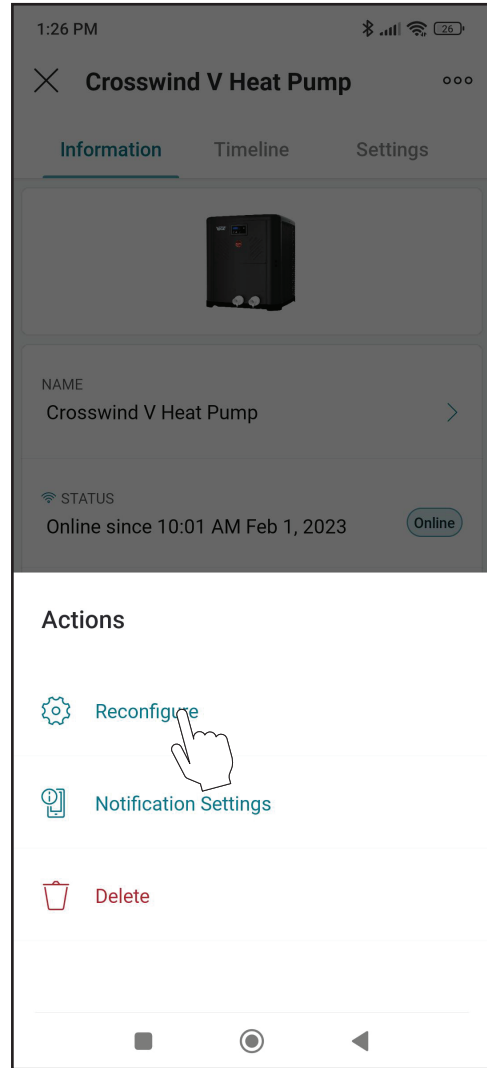

Figure 95. Open Unit Settings

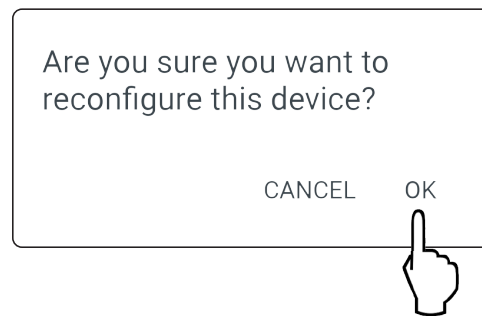

**Figure 96. Heater Settings Screen**

3. Click in the 3-dots icon again. The action menu is displayed. In “Actions” menu, select the option “Reconfigure” as shown in Figure 97.



**Figure 97. Select Reconfigure**



**Figure 98. Confirm Selection**

4. "Check your Device" screen will appear. Ensure to have the heater powered and Wi-Fi signal available in the area, then press "Ready" button. See Figure 99.

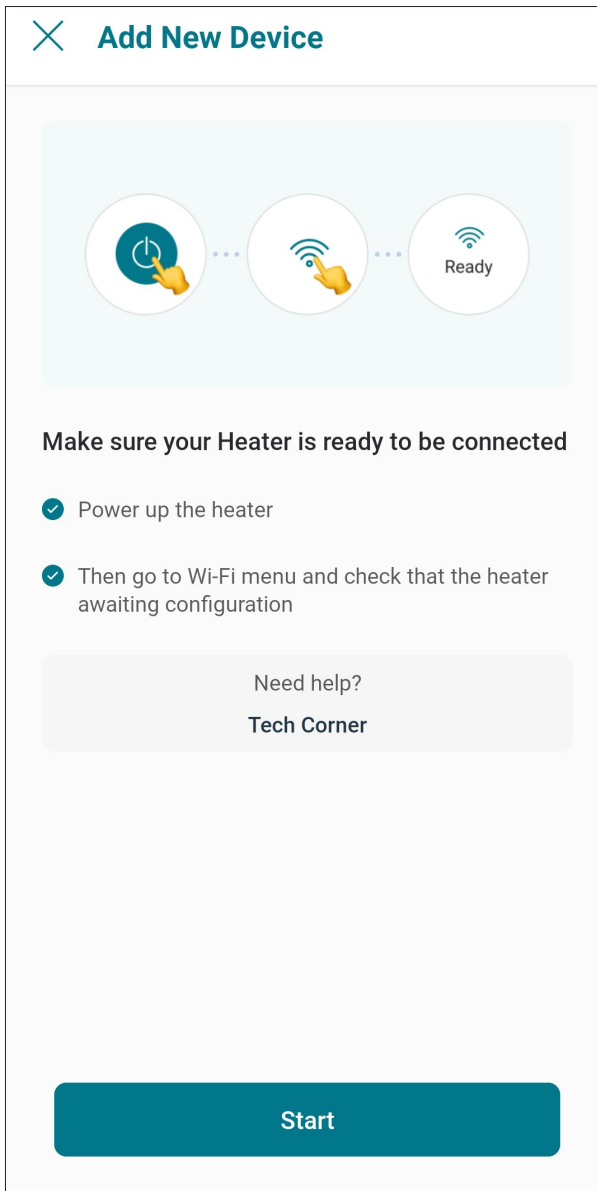

Figure 99. Check your Unit

5. **In Android:** Depending on your configuration, one or more devices will appear on the app. Select the HOTSPOT identifier that matches the unit's display as shown in Figure 100.

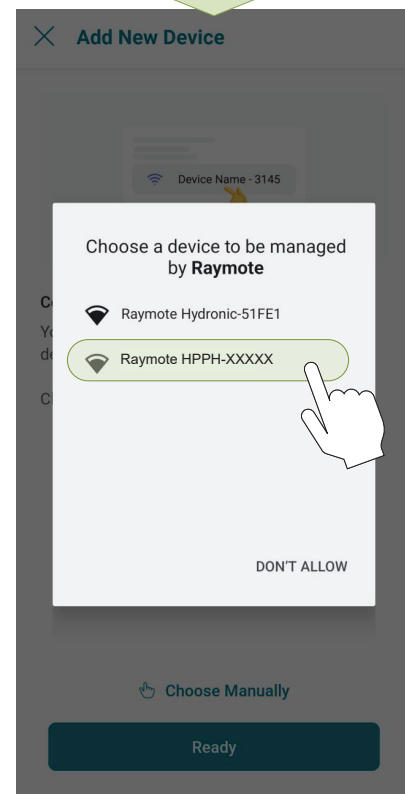
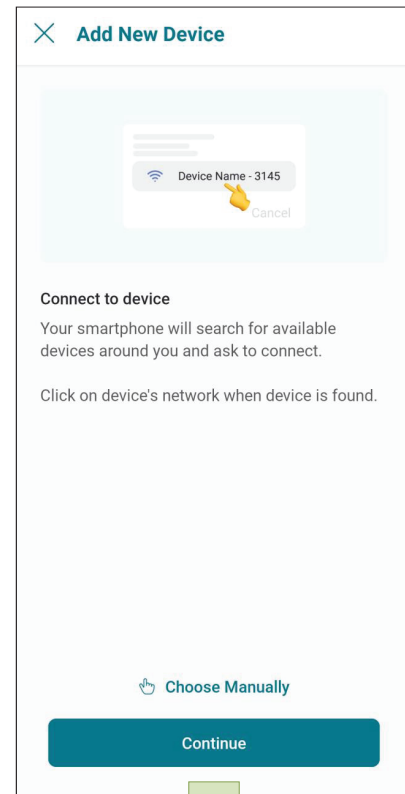

Figure 100. Connect with Android Smart Phone

6. **In iPhone:** Raymote app will start to scan nearby heaters. If you have multiple units ready to connect, stand closer to the unit you want to connect first.

Press "Join" to select the displayed heater that matches the HOTSPOT identifier, or press "Cancel" to start the process again. See Figure 101.

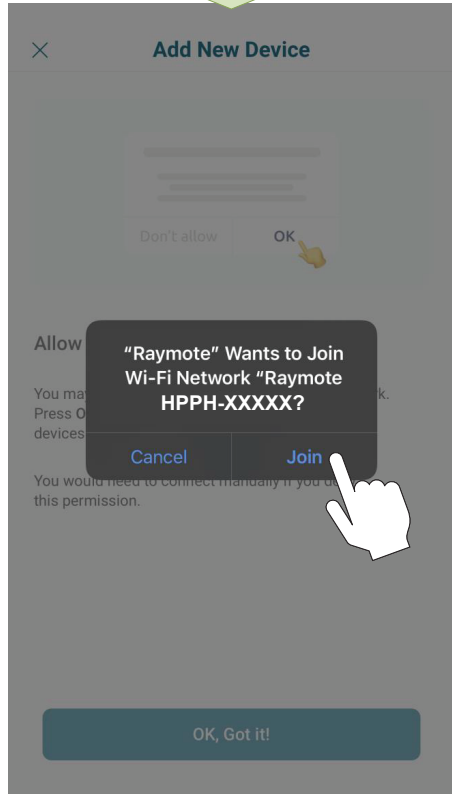
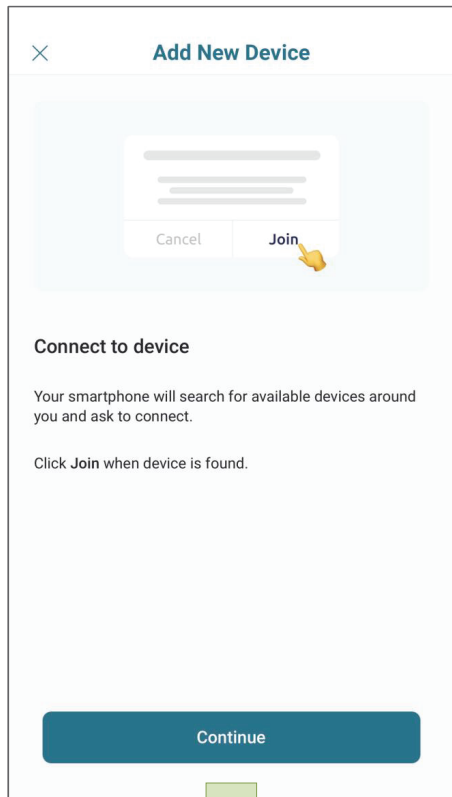

Figure 101. Connecting with iPhone

7. The "Wi-Fi setup" screen will appear. Select or enter the Wi-Fi network you want your unit to be connected to and enter the network password. See Figure 102.
8. Press the "Continue" button to proceed with unit connection. See Figure 102.

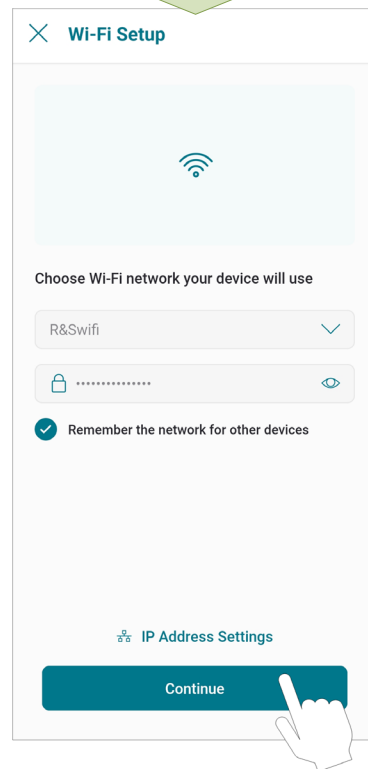
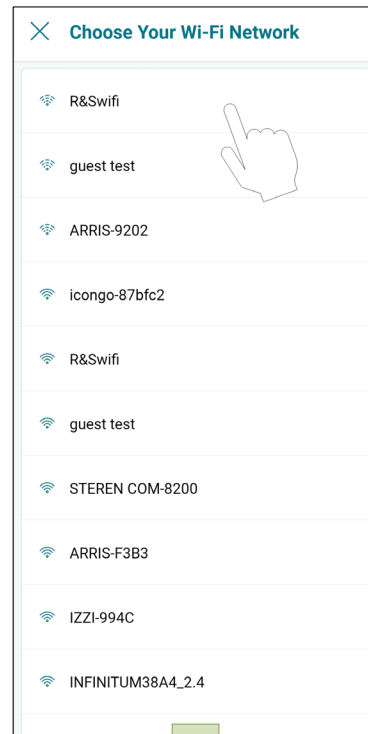

Figure 102. Wi-Fi Setup

**IMPORTANT: Raymote Wi-Fi module works with 2.4GHz Wi-Fi signals only.**

**Ensure to have a strong signal near the Heater, the Wi-Fi password and to use a 2.4 GHz network.**

**(IEEE 802.11, 802.11b/g/n/ax).**

9. Raymote app will provide the Wi-Fi credentials to your unit. This process may take a few seconds. See Figure 103.

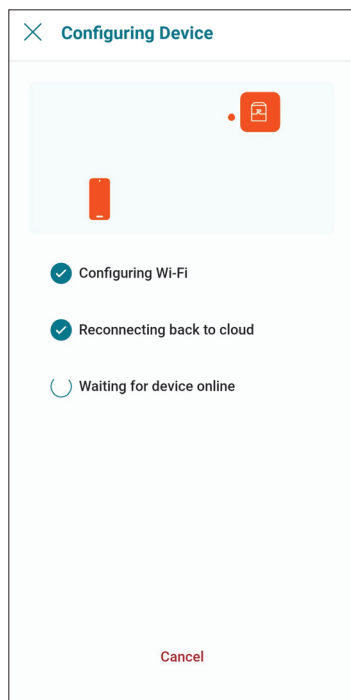

Figure 103. Configuring Device

10. Your device is now connected to Wi-Fi. You can change the name of your device here. See Figure 104.

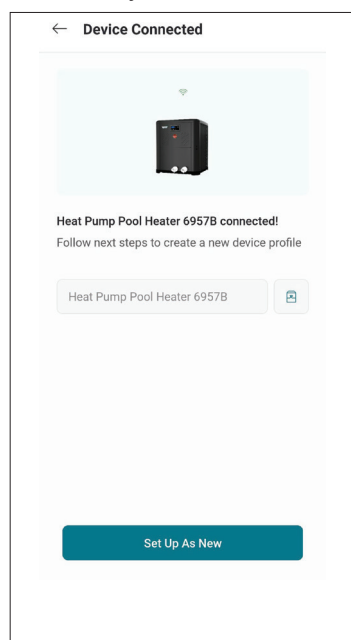

Figure 104. Name Your Unit

11. Press the "Set up as new" button to enter unit location, and other helpful info for future references. Press the "Apply recently used profile" button to use information previously applied to other heaters.

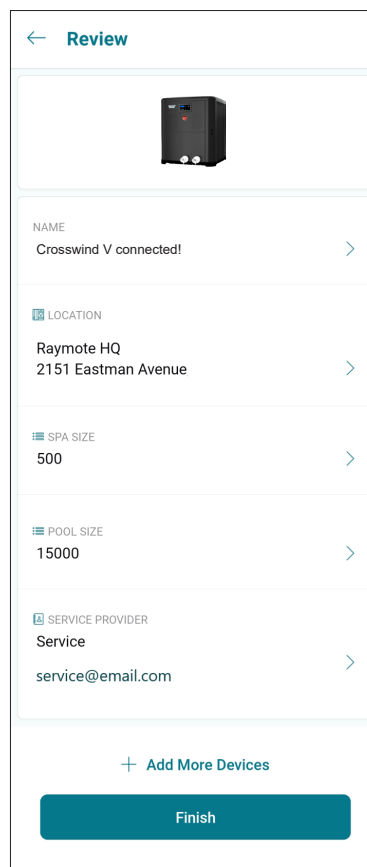

Figure 105. Device Setup Review

12. After completing the Raymote configuration, the unit will start broadcasting data to the Raymote cloud.

## Add a New User to your Organization

• As the Organization owner, you can add members of your family, friends and others that will be able to interact with your heaters. See Figure 106.

• In Raymote Partner accounts, you can add members of your company to gain access to heaters and clients registered within your Organization. See Figure 107.

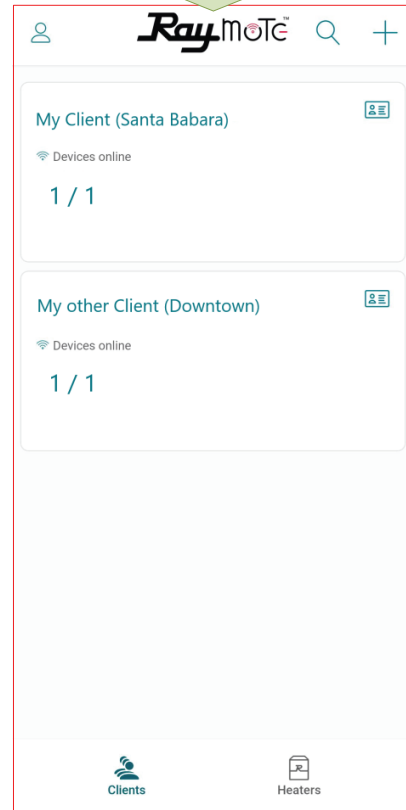
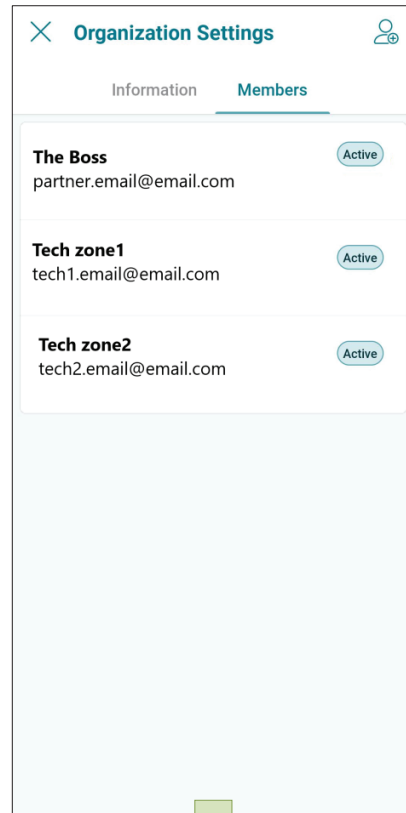
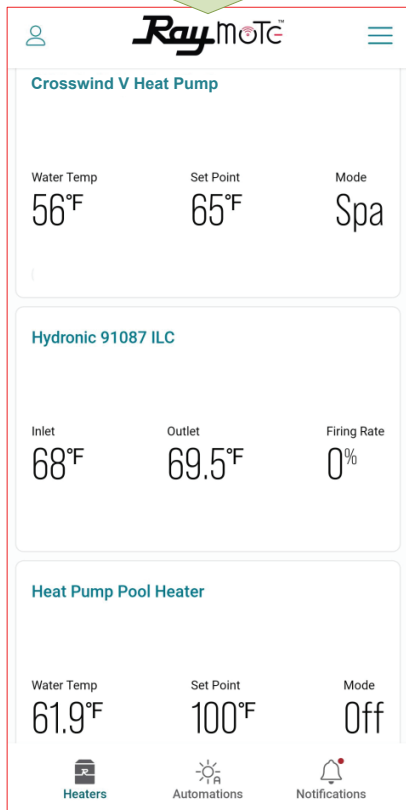
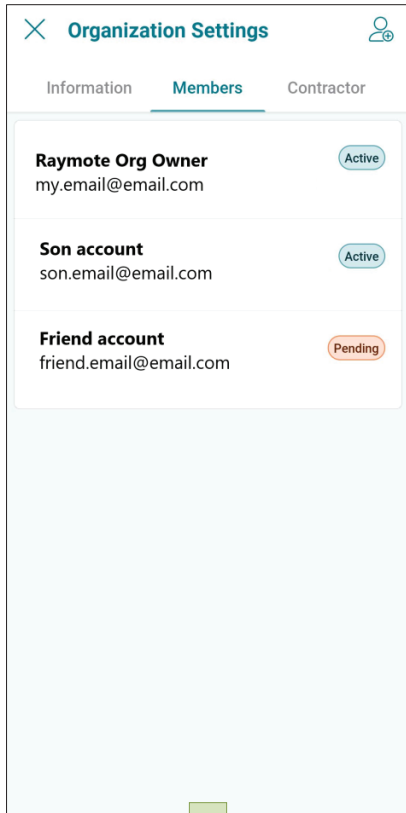

Figure 106. Organization Members Share Access to Heaters

Figure 107. Partners Accounts with Multiple Clients



## Add a Member to your Organization

1. In your smartphone, open the Raymote app.
2. Click on the top-left "User menu". Then, select "My Organization" option. See Figure 108.

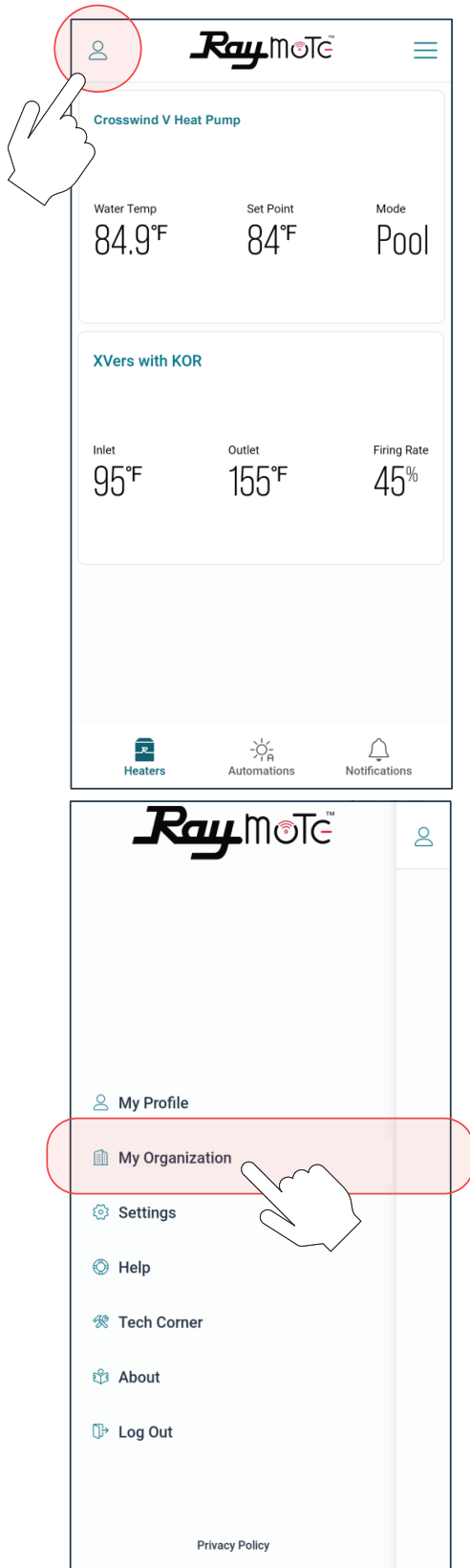

Figure 108. Select Organization Option

3. Go to "Members" tab. Member's list is displayed.
4. Click on the top-right icon to [Invite a New Member]. See Figure 109 and Figure 110.

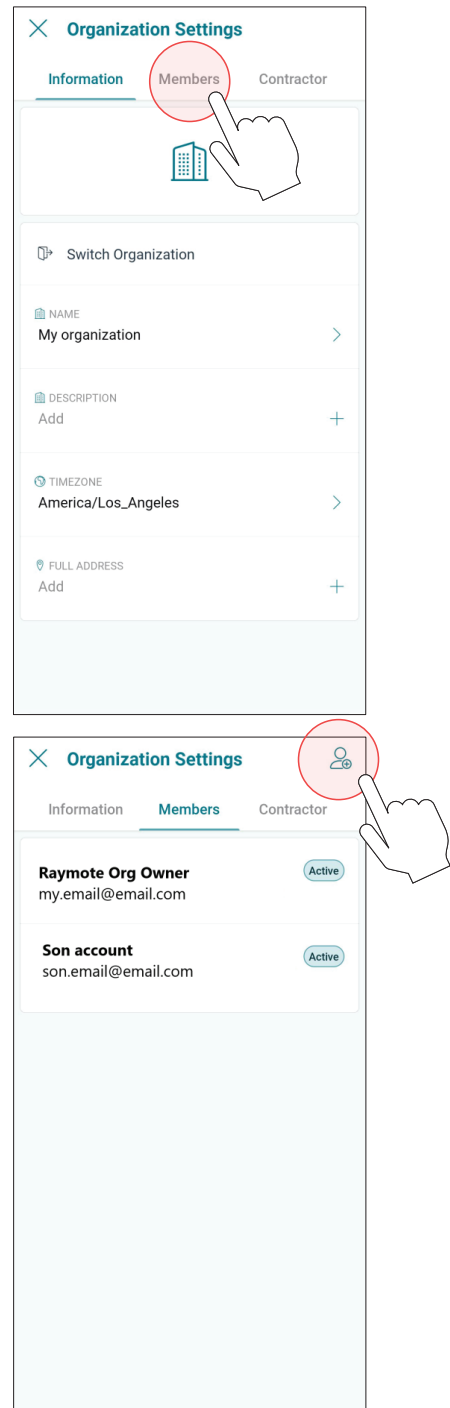

Figure 109. Invite a New Member to your Organization

5. Fill the invitation with new member's email, name, and role. Based on your selection, the new member can have different permits in your organization.
6. Click in the top-right icon to complete and send the invite. An email will be sent to the New Member to create a new Raymote user associated to your organization.

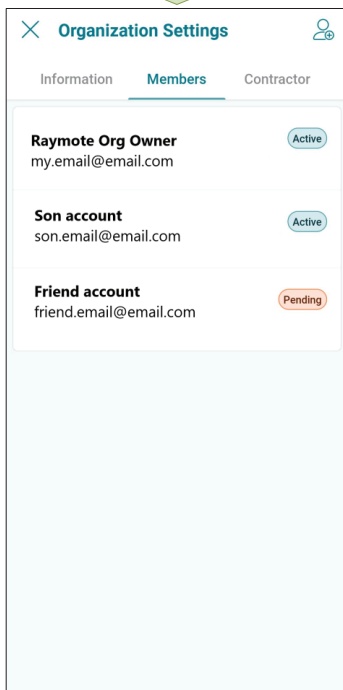
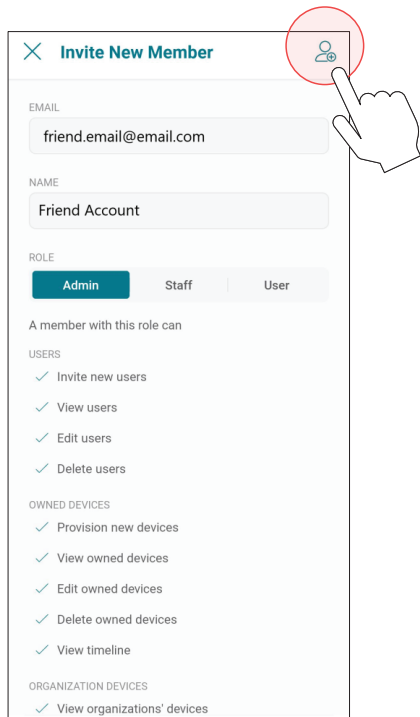

Figure 110. Invite a New Member

7. **IMPORTANT:** To complete the invitation, the new member needs to create a password from Raymote email invitation, to access your Raymote Organization.

## Client Accounts: Invite a Contractor

By inviting a Contractor or Distributor, you are giving access to heaters available in your organization to a third-party organization.

You can condition the access to your invited contractor as follows:

- For monitoring only.
  - To monitor and control your heaters.
    - o Access can be permanent or restricted to a certain period.
1. In your smartphone, open Raymote App.
  2. Click on top-left "User menu".
  3. Then, select "My Organization" option. See Figure 111.

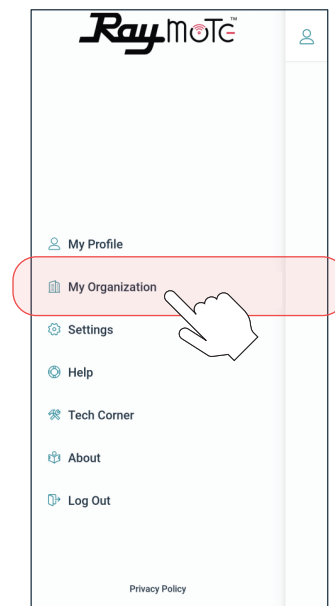
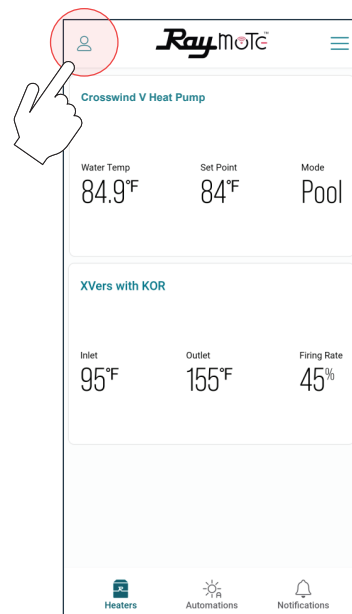

Figure 111. Select Organization Option

- Organization Settings page is displayed.
- Go to **[Contractor]** tab, and press [Invite Contractor]. See Figure 112.

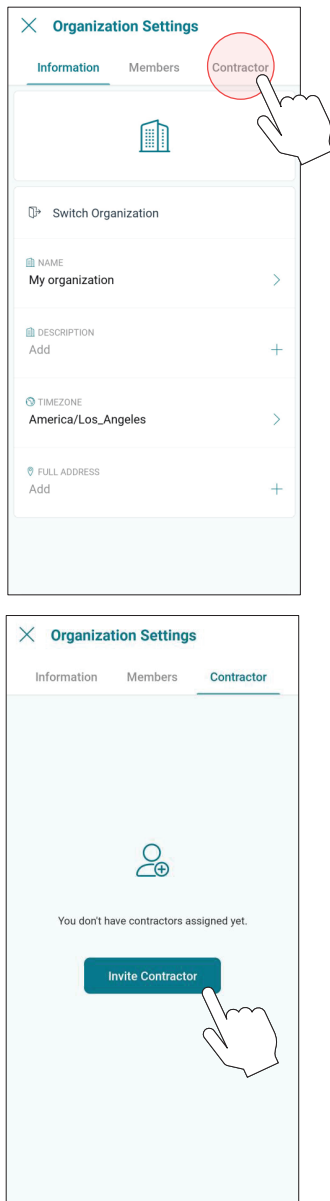

Figure 112. Click on “Invite Contractor”

**IMPORTANT:** Contractor must have an active Raymote “Partner” account to be able to connect your account with the contractor’s account.

- Add your contractor’s email and select the access options as needed. See Figure 113:
  - Allow Access** - Allows the contractor to monitor your heaters.
  - Allow Controlling Device** - Contractor can make changes to your heater configuration and create automation routines.
  - Access Period** - Defines for how long the contractor can monitor or interact with your heaters.

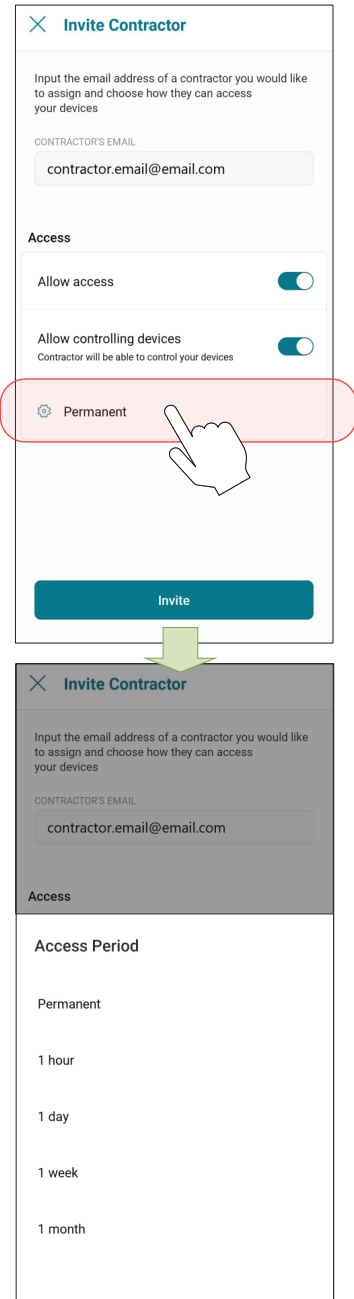

Figure 113. Enter Contractor Email and Access Level

- When ready, press **[Invite]**. An invitation/request will be sent to the contractor's Raymote account. See Figure 114.
- IMPORTANT:** To complete the invitation process ask your contractor to accept the request directly from their Raymote App account.
- When done, you can always edit the permissions, remove the contractor, or cancel the invitation in Organization’s settings, **[Contractor]** page.

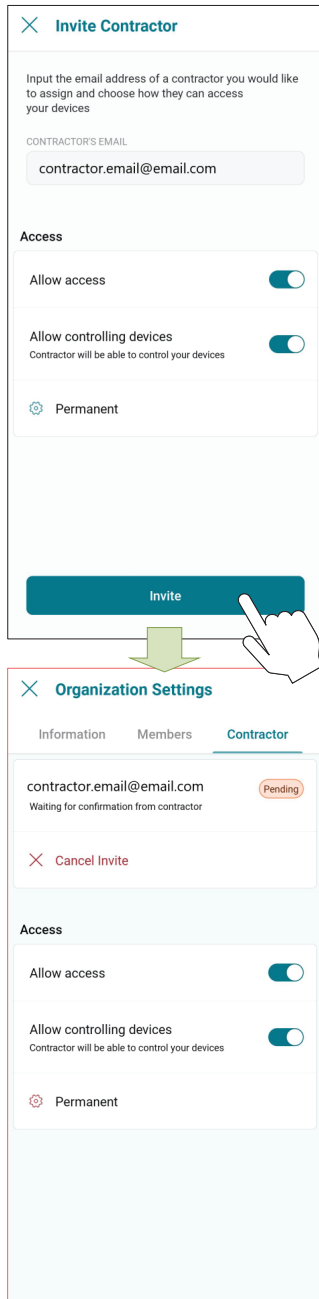

Figure 114. Send the Invite

**NOTES:**

•“Invite a contractor” option is only available for Raymote Client accounts.

•Contractor must have a Raymote partner account to get requests from client accounts.

•Raymote partner accounts can invite only new clients to Raymote. If the client already has a Raymote account, ask the client to send a request from “Contractor” option.

## Partner Accounts: Invite New Clients

With a Raymote Partner account, “Contractor” or “Distributor”, you can:

- Invite and "Manage New Clients"
- Connect and configure your clients' heaters
- Monitor and control residential and commercial heaters
- Create automation routines and alerts for your clients
- Invite members to your organization

1. In your smartphone, open Raymote app.
2. Click on bottom-left [Clients] icon.
3. Now, press [New Client] button or top-right [+] icon. See Figure 115.

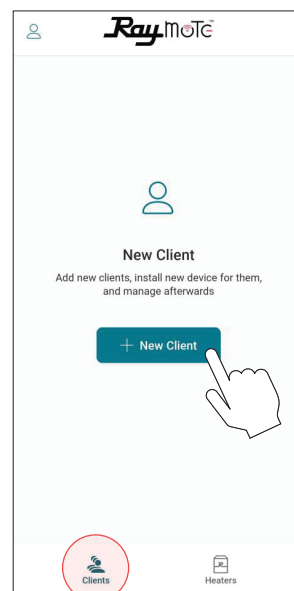

OR

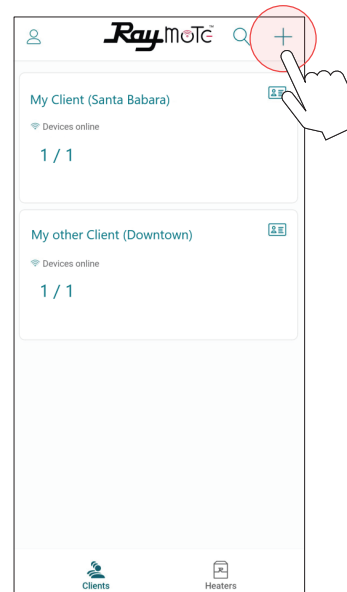
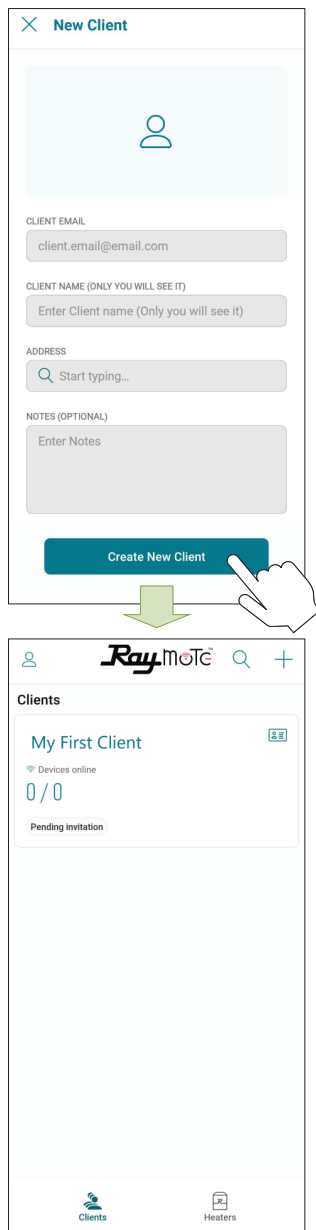

Figure 115. Add a New Client

4. Fill "New Client" form with your client's email, name, and address.
5. When ready, press **[Create new client]**. An Raymote invite email will be sent to your new client. See Figure 116.



**Figure 116. Enter Client Email and Invite**

6. Ask your **Client** to create a new Raymote account from the email invite.
7. You can access your client's heaters by clicking in each client tile. See Figure 117.

**NOTES:**

•“Add New Client” option is only available for Raymote partner accounts.

•Raymote partner accounts can invite only new clients to Raymote. If the client already has a Raymote account, ask the client to send a request from “Contractor” option.

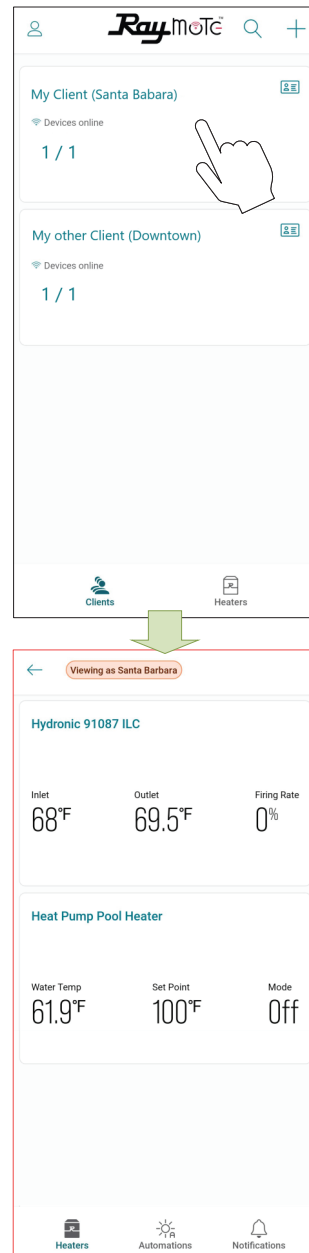

**Figure 117. Access your Client's Heaters**

## Switch to Other Organizations

If your Raymote organization has 1 or more sub organizations, you can switch to other organization by using the "Organization" tree or search function.

1. Open the main menu by clicking the top left icon. See Figure 118.
2. On the main menu, click on the "Organization" option. See Figure 119.

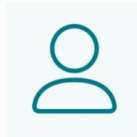

Figure 118. User Menu

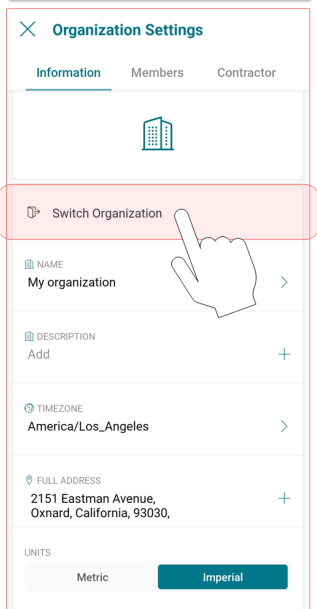
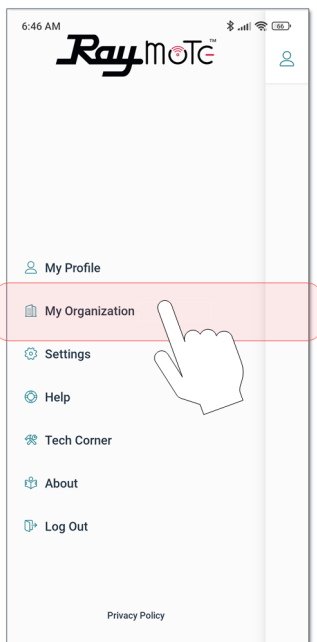
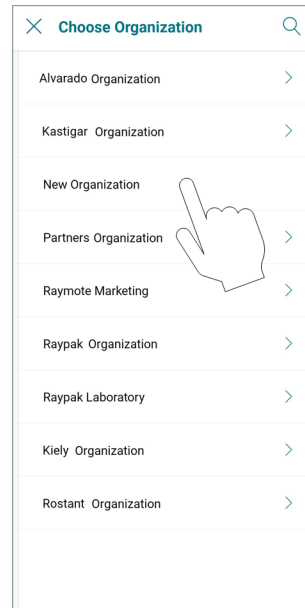

Figure 119. Switch Organization

3. In "Organization Settings" page, select "Switch organization" option. See Figure 119.
4. "Choose organization" screen will be displayed and it will show all the available organizations. Navigate the sub-organization list or use the search tool to locate desired organization. See Figure 120.



OR

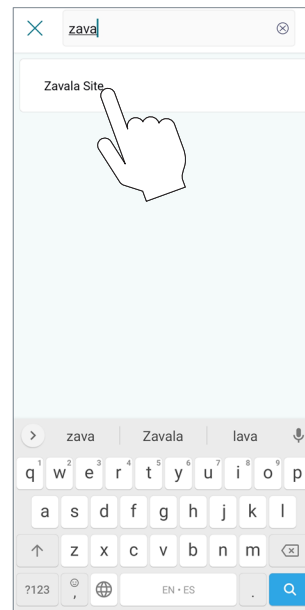

Figure 120. Choose Organization

## Connectivity Troubleshooting

- With your cellphone check that Wi-Fi signal is available next to the unit. Ensure that your Wi-Fi network meets these specifications:
  - Supported networks - Wi-Fi 2.4GHz (802.11 b/g/n).
  - Password encryptions - WEP, WPA, WPA2.
  - Wi-Fi signal icon of 2 bars (-60dB) or better at heater location. See Figure 121.

	Signal [dB]	Quality
	≥ -30	Excellent
	-50	Very Good
	-60	Good
	-70	Limited
	-80	Bad
	-90	Unreliable

Figure 121. Wi-Fi Signal

- Use the built-in Wi-Fi network options in your cellphone or use a Wi-Fi network scanner app, like Fing Network Scanner for iPhone or Wi-Fi Analyzer for Android smart phones, to check signal strength.

If you are having troubles connecting your heater to the Raymote app, try these common solutions:

- Check that Wi-Fi signal name and password are correct.
- In case of a change, proceed to reset Wi-Fi credential from heater touchscreen and reconnect the heater with Raymote app. See Figure 122.

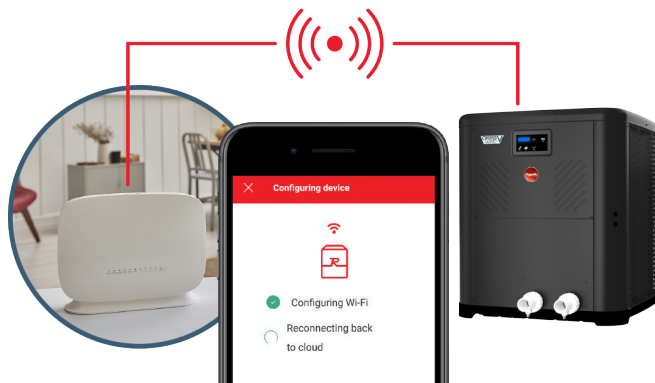

Figure 122. Reset Wi-Fi Credential

- Check that your Wi-Fi signal strength is strong enough to reach the heater.
  - Reduce distance between Wi-Fi router and the heater.
  - Add a Wi-Fi range extender to cover heater zone or enable a new Wi-Fi access point. See Figure 123.

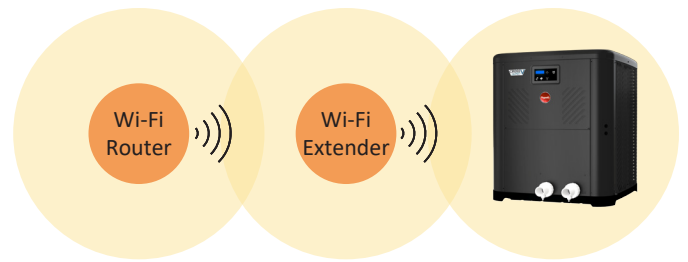

Figure 123. Wi-Fi Extender

- Update Raymote app to the latest version.



Figure 124. Update Application

- Power-cycle your heater and restart Raymote app.
- Check the settings on your router or Wi-Fi access point.
  - If needed, enable a dedicated 2.4 GHz network. 5GHz signals are not compatible with Raymote.
  - When applicable, ensure to have the permissions from IT or Building Manager.
  - Check if MAC address whitelisting is required.
  - Check if Static IP is required. See Figure 125.



Figure 125. Wi-Fi Access Point Settings

## 27. EXTERNAL CONTROL OUTPUTS

Crosswind V heater controller offers multiple external optional outputs designed to drive 2-valve actuators, a single-speed pump, a variable-speed pumps and 2 auxiliary relay outputs for On/Off devices like blowers, lights, or water feature actuators. The controller is also equipped with an optional auxiliary input to enable external fault or interlock. Additionally, the Crosswind V controller provides built-in integration with solar heaters allowing the heat pump controller to select or bypass solar heater water supply.

The available optional inputs and outputs are listed below. Refer to Figure 126 for the location of each terminal.

- **Valve 1 and 2 Outputs [P19 and P20].** Standard 24VAC outputs to control 2-way or 3-way valve actuators.
- **Single-Speed Pump Output [P5].** Low voltage (24VAC) output designed to command a single-speed pump (or others on/off device). This output must be used in conjunction with a field-supplied 24VAC relay.
- **Protégé Variable-Speed Pump [P12].** Dedicated communication port to control Raypak Protégé variable-speed pumps.
- **Digital Control Variable-Speed Pump [P8].** 5-pin output to command variable-speed pumps compatible with 30VDC digital signals for speed selection.

- **Auxiliary 1 and 2 outputs.** General purpose relay outputs to control On/Off devices. These outputs do not supply power. Use in conjunctions with external power supply. Use additional field-supplied relays for applications above 3 amperes.
- **Auxiliary Input [P11].** The control provides an optional auxiliary input that can be configured to display and record a fault or to trigger an interlock and inhibit heater operation.
- **Remote control selector [P7].** The control provides a standard 3-wire selector to work in conjunction with external automation controllers. Please refer to section 16 in page 30, for details about wiring and configuration of remote mode selector.
- **Solar Heater integration [P9 and P11].** The control provides a 10K sensor input in P11 and a 24VAC 3-way valve standard output in P9 to integrate the Heat pump operation with a solar heater.
- **Water Flow Switch.** Wiring instructions for connecting the external Water Flow Switch within the heater's electrical junction box.

The factory-default operation mode for these components is disabled or set to be commanded from Raymote app.

- Refer to section 13, "Installer Menu", in page 21 to set the operation mode of each terminal.
- Refer to section 14, "Schedule Menu" in page 25 for details about the built-t local schedule.
- Please refer to sections 25 and 26 of the Raymote app, for detailed instructions on how to connect the unit to Wi-Fi and create online automation.

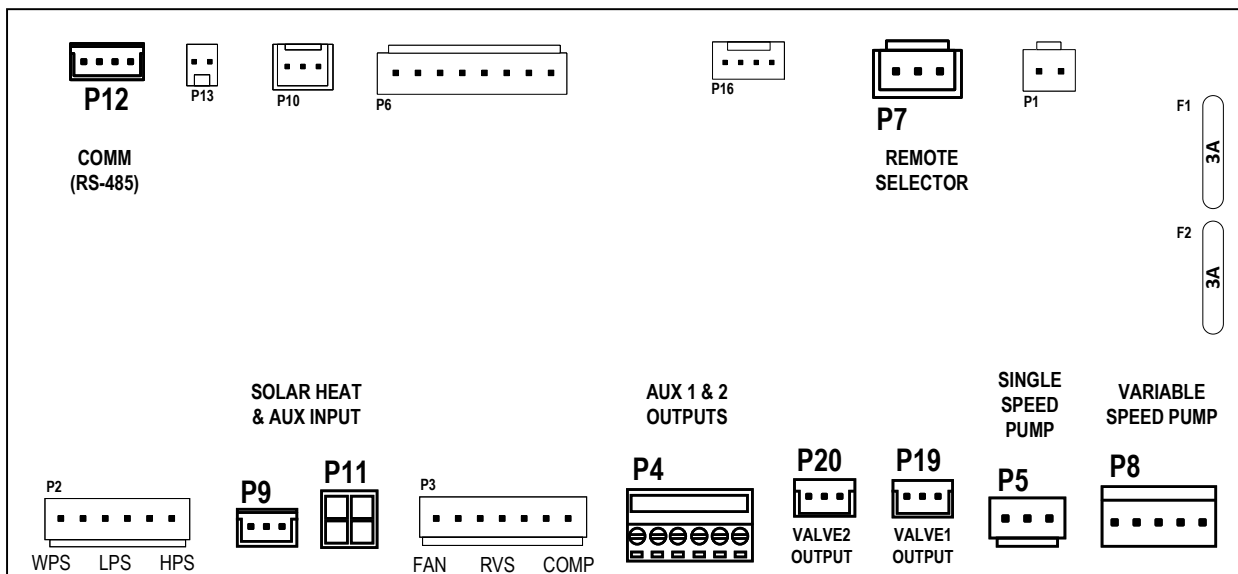

Figure 126. External Control Terminals



## Instruction for Wiring External Devices

This section outlines the general steps to wire the optimal control outputs and inputs from the pool devices to the heater control board. For more information about each terminal, please refer to the section corresponding to each optional terminal.

**⚠ WARNING:** To properly service this equipment, you need to have a certain level of expertise, electric and mechanical skills, and access to the necessary tools and equipment. If you do not possess these requirements, please do not attempt to perform any service on this equipment except for the procedures recommended in this manual.

### Important installation notes for control signals wiring:

- Before performing any electrical installation, make sure to de-energize the heater.
  - Control wires should be run in a separate conduit to avoid interference with other wires.
  - Use the grommet/knockouts available in the corner post to route wires into the heater. Ensure that liquid-tight connectors are used to prevent water or dust intrusion.
  - Low voltage wiring should not be run together with high voltage lines.
  - Use the appropriate relays for your application, ensuring that the relay coil is compatible with the external power supply. For the single-speed pump output, use a 24VAC relay.
  - Use the supplied accessory harness to connect to terminals P4, P5, P7, P8, P9, and P11 on the heater.
1. Before starting any work on the unit, make sure to shut off all power to avoid the risk of electrical shock or damage to components.

2. To access the heater's front control cover panel, use a 1/4" hex head screwdriver to unscrew the six (6) screws. See Figure 127.

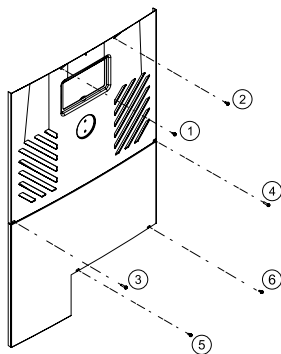

Figure 127. Sheet Metal Screws to Remove Control Panel

3. To remove the front panel, pull the bottom of the panel downward and outward, and then disconnect the wire attached to the rear of the user interface. The panel should now be free for removal. See Figure 128 and Figure 129.

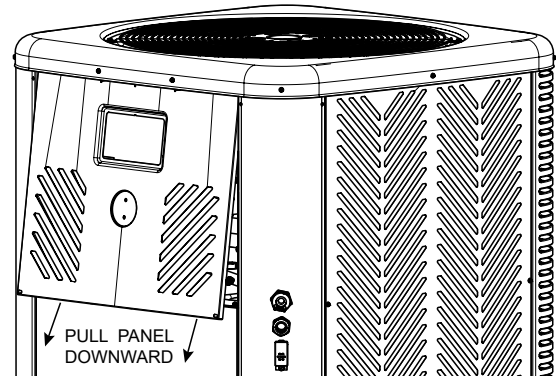

Figure 128. Detach Front Panel

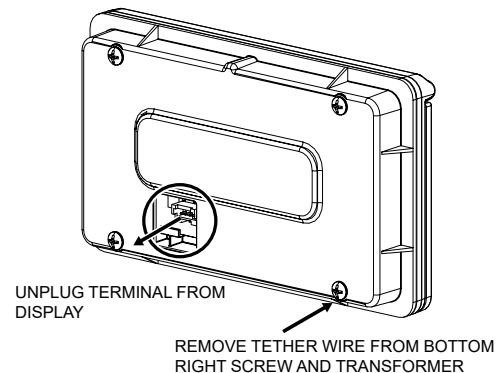

Figure 129. Remove Wiring from Display

4. Set the control panel cover aside to reinstall when wiring is completed.
5. Use the grommet(s) to run the control and/or power wires from the external device(s) to the heater control box. See Figure 130.

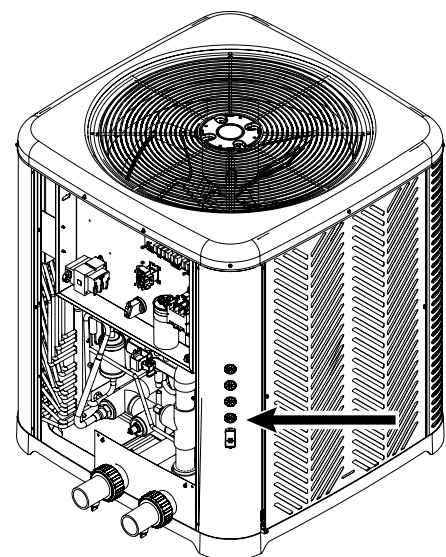

Figure 130. Use the Grommets

6. In the case you decide to remove the grommets to connect external devices to the heater, run wires using metallic conduit or outdoor-resistant cables. Then, connect the conduit or cables to the knockout using liquid tight connectors to prevent water or dust from entering the system. See Figure 131.

**NOTE:** Please refer to Article 680 of the National Electrical Code for general requirements related to swimming pools and equipment, and to Article 440 for special considerations that are necessary for circuits supplying hermetic refrigeration motor/compressors. Additionally, make sure to refer to the electric specifications and standards provided by your local authorities.

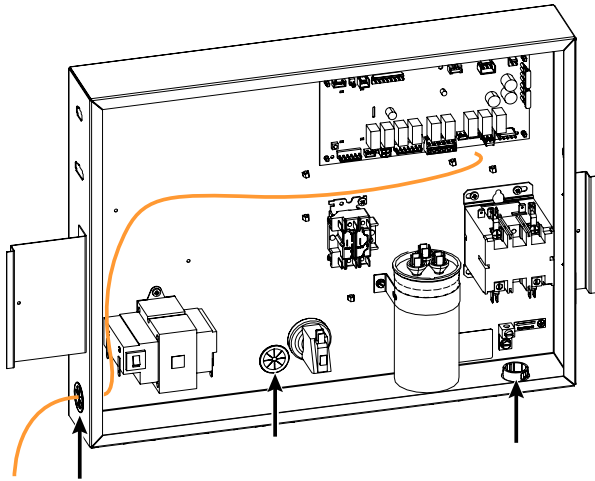

Figure 132. Grommets in Control Box

8. Connect the external wires to the appropriate terminal(s) on the control board. Refer to the following sections for details about wiring each terminal using the supplied harness accessories and field-supplied parts.

### Valve Control Actuators Wiring

The control is designed to operate standard 24VAC 2-way and 3-way valve actuators. By default, valve outputs 1 and 2 are configured to be controlled from the Raymote app via Wi-Fi. In this mode, the heater must be connected to a local Wi-Fi network to manually command the valves or use online automation routines.

Alternatively, the valve control can be set to operate automatically by the heater controller using the “Pool-Spa” mode. Please refer to section 13 (Installer menu) on page 21 for details about valve control modes.

In “Pool-Spa” mode, the control will set the valves to the requested state when there is an active thermostat demand for pool or spa mode. If the control also operates the pump, it will shut off for 30-seconds before the valves change state to avoid pump head pressure during the transition. The display will show “Valve Chng Delay” during this time. The valve outputs will not change until there is a change in operation mode (any pool or spa mode).

1. Follow the general instructions for wiring external devices to connect the valve actuator(s) harness from the valves to the control board of the heater. See Figure 133.

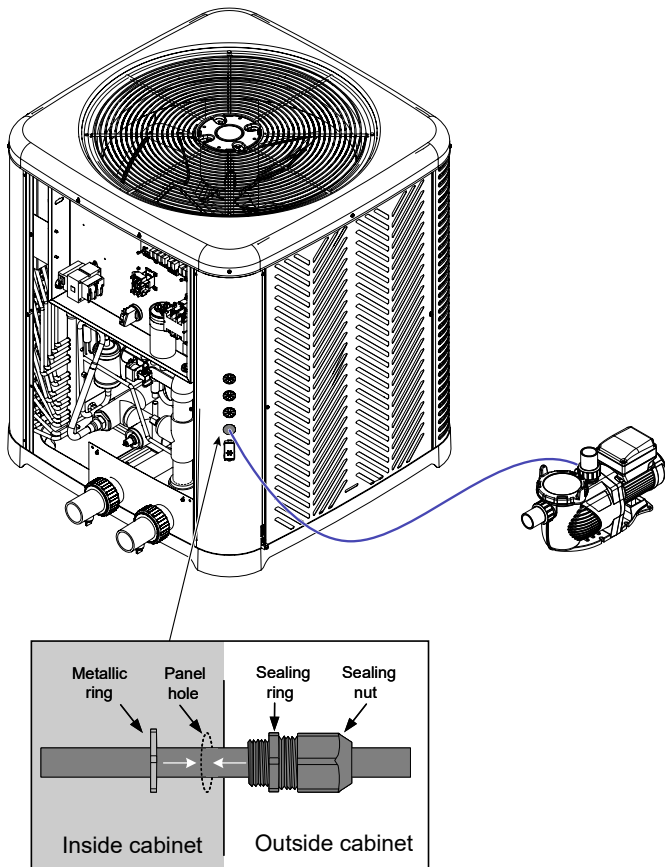

Figure 131. Wiring External Devices Using Liquid Tight Connectors

7. Use the grommets in the control box to run wires from inside the corner post to the inside of the box, up to the control board terminal(s). See Figure 132.
  - a. Use the grommets located next to the transformer and pressure switch for low-voltage signals and low-voltage external power sources.
  - b. Use the grommet located under the main contactor for any additional high-power signals or high-voltage external power sources.

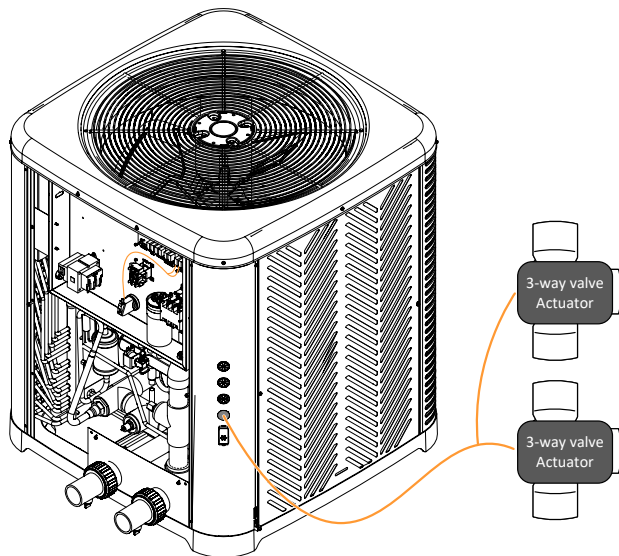

Figure 133. Wiring Valve Actuators

2. Connect the field-supplied valve actuator harnesses to the terminals of the control board marked as "VALVE 1" [P19] and "VALVE 2" [P20]. Note that the rating of the control contacts is 0.75A at 24VAC. See Figure 134.

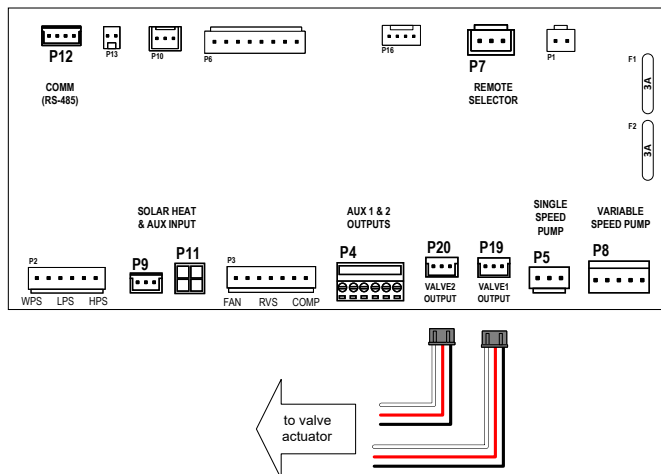

Figure 134. Wiring Valve Actuator Harnesses

### Single-Speed Pump Control Wiring

The control is designed to operate a single-speed pump with an output of 24VAC at a maximum of 0.75A. To switch power and energize the pump, a field-supplied 24VAC relay is required with common and normally-open terminal(s) rated per pump specifications.

By default, the single-speed pump output is set to be controlled from the Raymote app using Wi-Fi. In this mode, the heater must be connected to a local Wi-Fi network to manually command the pump or utilize online automation routines. Additionally, the single-speed pump output can be controlled by the built-in local schedule with up to four periods of operation per day or by the built-in automatic mode "Heater Demand," which commands

the pump whenever the heater requires heat (or cool). For more details about the single-speed pump control modes, please refer to section 13 of the Installer menu on page 21.

1. Check the power requirements of your single-speed pump to determine the necessary power source. Most pumps run at either 120V or 240V.
2. Follow the general instructions for wiring external devices to run the pump power cables and power source wires from the pump and power distribution box to the control box of the heater.

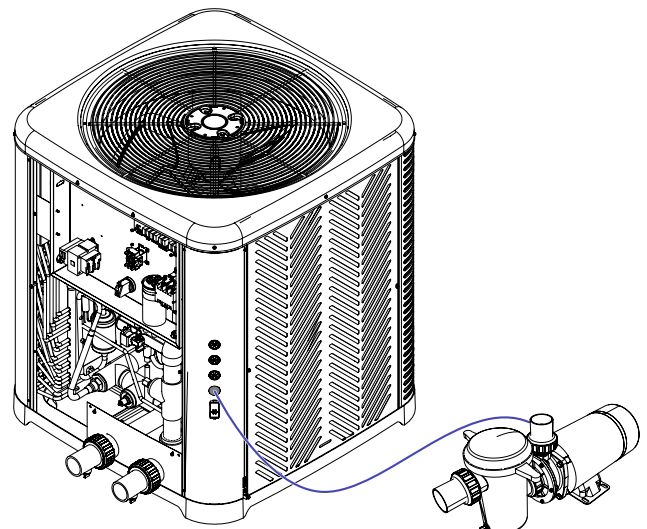

Figure 135. Wiring Simple Speed Pump

3. Install a field-supplied relay inside the control box. See Figure 136. The relay shall have a coil for 24VAC, and contact terminals rated to the current specifications of the pump. The next components are recommended for this application

a. For devices that require less than 10 amps, use an OMRON LY2F AC24 (Raypak Kit # 008784F) or similar relay.

b. For devices that require 10 amps or more, use an OMRON G7L-2A-BUBJ-CB AC24 or similar relay.

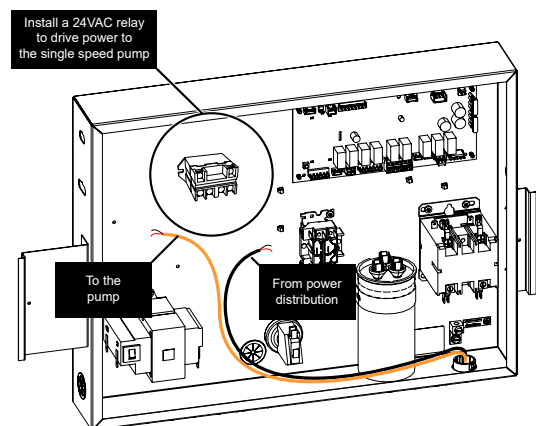

Figure 136. Install Relay in Control Box

- Use the harness adapter supplied in the accessory bag labeled as “single-speed pump” to connect the field-supplied relay to the terminal of the control board marked as “PUMP” [P5]. Connect the other end of the harness to the coil terminals of the relay, as shown in Figure 137.
- Connect the wires coming from the pump and the power distribution box to the relay contact terminals, as shown in Figure 137.

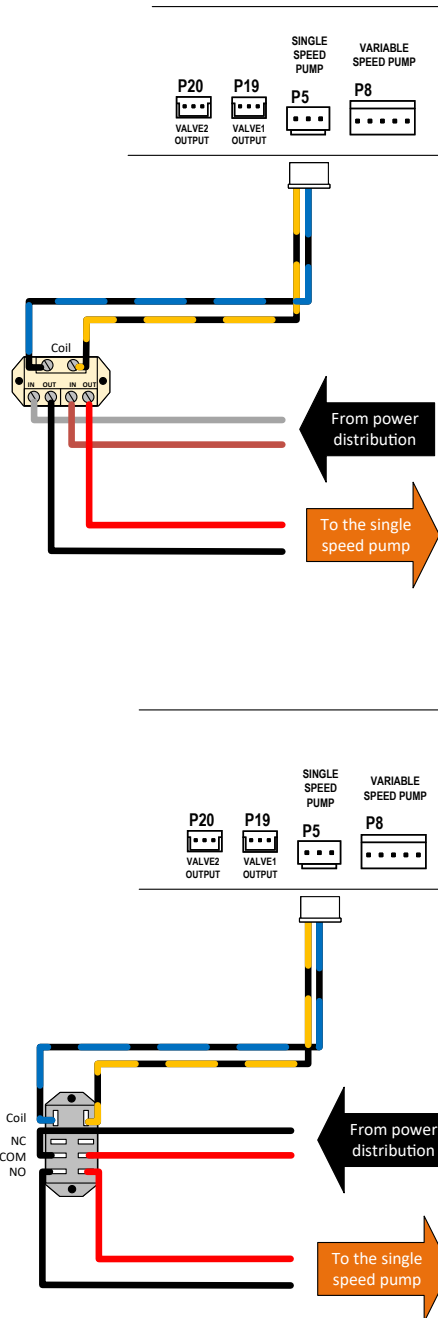

Figure 137. 24VAC Relay Wiring

## Protégé Variable-Speed Pump Control Wiring

The Crosswind V control is designed to operate Raypak Protégé variable-speed pumps. It comes equipped with a dedicated communication port labeled "COM" [P12]. To connect a Protégé variable-speed pump to the Crosswind V, use the RS-485 Modbus harness (P/N 652281).

By default, the variable-speed pump control is disabled. However, when the option is enabled and set to operate a "Protégé VSP", the default control mode is to command the pump using the Raymote app via Wi-Fi. To use this mode, the heater must be connected to a local Wi-Fi network to manually command the pump or use online automation routines. Additionally, the variable-speed pump can be controlled by the built-in local schedule with up to 4 periods of operation per day or by the built-in automatic mode "Heater demand" that commands the pump whenever the heater needs heat or cool. For details on the single-speed pump control modes, refer to section 13 in the Installer menu on page 21.

- Follow the general instructions for wiring external devices to run the RS-485 harness from the Protégé variable-speed pump to the control box of the heater.
- Connect the keyed circular connector of the pump harness to the pump. See Figure 138.

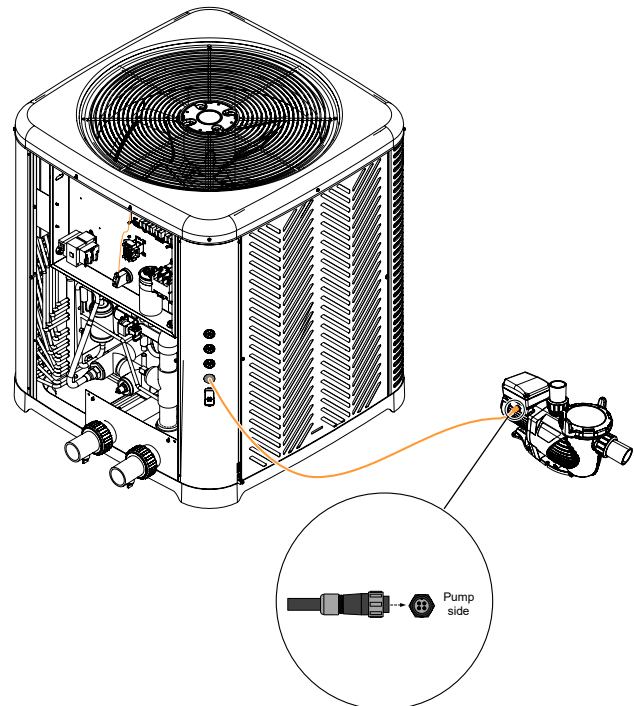

Figure 138. Keyed Circular Connector

- Then connect the other end of the RS-485 Modbus harness to the terminal labeled as "COM" [P12] on the control board. See Figure 139.

- By following this configuration, the control board can operate the field-supplied relay, which in turn supplies power to the single-speed pump and allows it to turn on or off.

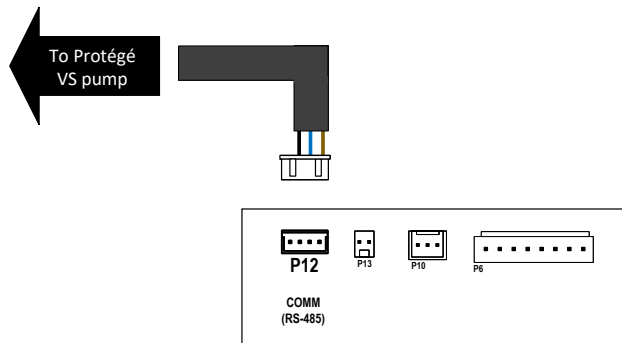

Figure 139. Wiring 24VAC Relays

4. With this setup, the control board can control a Raypak Protégé variable-speed pump. Make sure to enable and configure this option from the Installer menu of the heater.
5. If the heater displays “Pump Ctrl Fail,” ensure that the Modbus harness is connected on both ends, and the pump settings for the Modbus address are “2” and the Baud rate is set to 9600. For more information on the Protégé variable-speed pump settings, please refer to the [Protégé Variable-Speed Pump manual](#).

## Digital Control Variable-Speed Pump Wiring

The control is designed to operate multiple brands and models of variable-speed pumps that are compatible with digital control speed selection. It features a dedicated 5-pin terminal labeled as “VAR PUMP” [P8], which provides up to 4 digital outputs of 30VDC that are compatible with the external control port of most common variable-speed pump brands in the pool industry.

Table G below provides a list of some of the brands and pump models that can be compatible with the 30VDC digital output-input control for speed selection. It's important to note that some models may require an adapter, add-on, or wiring kit to work with this control output, while other variable-speed pump controllers have the digital input terminals built-in and ready to connect.

Brand	Models	Note
Hayward	Maxflo VS™, Super Pump® VS, TriStar® VS, THP VS Pump family, HCP3000 series VSP, others*	<ul style="list-style-type: none"> <li>• Compatible with Crosswind V 30VDC digital outputs and Auxiliary relay outputs.</li> <li>• The pumps may require to setup a DIP switch selector.</li> </ul>
Pentair	IntelliPro®, IntelliFlo®, SuperFlo®, SuperMax®, WhisperFlo®, Max-E-Pro®, others*	<ul style="list-style-type: none"> <li>• Compatible with Crosswind V 30VDC digital outputs and Auxiliary relay outputs.</li> <li>• The pumps may require enabling the digital selector from the pump configuration menus.</li> <li>• These pumps may require an IntelliComm® control center, IntelliComm® II Interface adapter, the “relay control board” or “digital input wiring kit”.</li> </ul>
Waterway	Power Defender 165 / 225 / 270, others*	<ul style="list-style-type: none"> <li>• Compatible with Crosswind V 30VDC digital outputs and Auxiliary relay outputs.</li> </ul>
Jandy	VS PlusHP, VS FloPro, others*	<ul style="list-style-type: none"> <li>• These pumps don't have direct compatibility with Crosswind V 30VDC digital outputs</li> <li>• Crosswind V Auxiliary relay outputs can be used to control these pumps.</li> </ul>
Speck Pumps	BADU EcoM3 V	<ul style="list-style-type: none"> <li>• Compatible with Crosswind V 30VDC digital outputs and Auxiliary relay outputs.</li> </ul>

Table G. Compatible Pump Models and Brands

**\*NOTE:** Before connecting the digital control outputs of the heater to a variable-speed pump, carefully review the installation and operation manual to confirm compatibility and determine if any additional components or configurations are necessary for the pump controller. This information can be found in sections titled:

- External control via digital inputs
- Connecting to an automation system
- Drive low voltage connections
- Using external input signal
- External relay speed control wiring
- Remote selection of pump speed
- Digital input wiring
- Control system relay contacts

By default, the variable-speed pump control is disabled. However, when the variable-speed pump option is enabled and set to operate in the "4-speed control" mode, the default control mode is set to command the pump with the Raymote app via Wi-Fi. In this mode, the heater must be connected to a local Wi-Fi network to manually command the pump or use online automation routines. Furthermore, the variable-speed pump can be controlled by the built-in local schedule with up to four periods of operation per day, or by the built-in automatic mode "Heater demand," which commands the pump whenever the heater requires heat or cool. For more information on the single-speed pump control modes, please refer to section 13 of the Installer menu, located on page 21.

1. Follow the general instructions for wiring external devices and run a 5-conductor cable from the pump controller or digital interface, to the control box of the heater. The specific pump controller to be used is determined by the manufacturer and model of the pump. Refer to the installer manual of your variable-speed pump for more details.

2. Inside the heater's control box, use the harness adapter labeled "Pump speed selector" that comes with the accessories bag to connect the 5-conductor cable to the control board terminal labeled "VAR PUMP" [P8]. The adapter can supply 4 digital outputs at 30VDC and a ground signal. Make sure to identify the wires in both ends of the 5-conductor cable. Refer to Figure 142 for guidance.
3. Connect the other end of the 5-conductor cable to the digital input terminals on the variable-speed pump controller or the digital to RS-485 pump control interface. Figure 143 through Figure 147, provide examples of connections for certain variable-speed pump brands and models. Please refer to the installation and configuration manual of your variable-speed pump for more details on connecting and configuring the digital input speed selector.
4. Once the wiring is complete, make sure to configure the variable-speed pump controller or interface adapter according to the manufacturer's specifications. Follow the instructions provided by the pump manufacturer to ensure compatibility and correct operation of the pump.

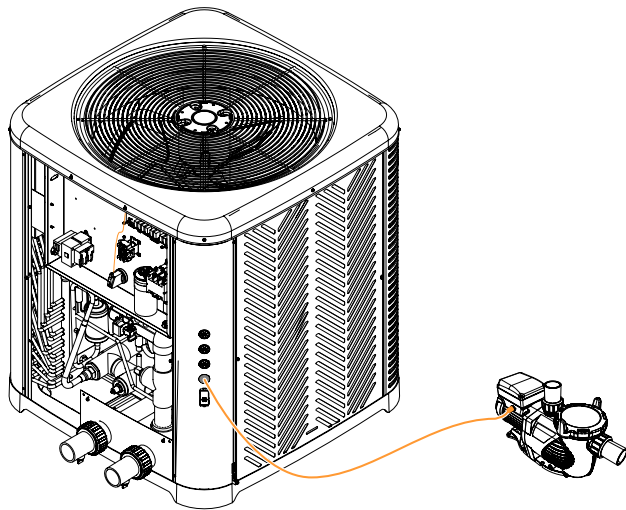

Figure 140. Cable Routing to the VS Pump Controller

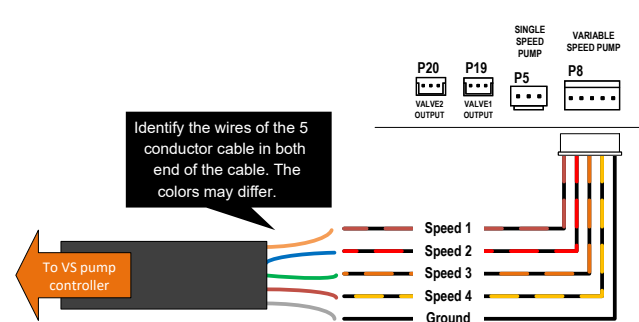

Figure 142. 5-Conductor Cable Wiring

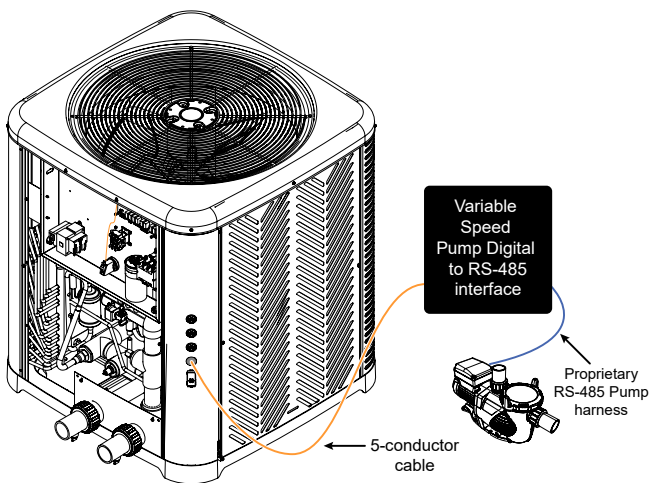

Figure 141. Cable Routing to a VS Pump Digital Interface

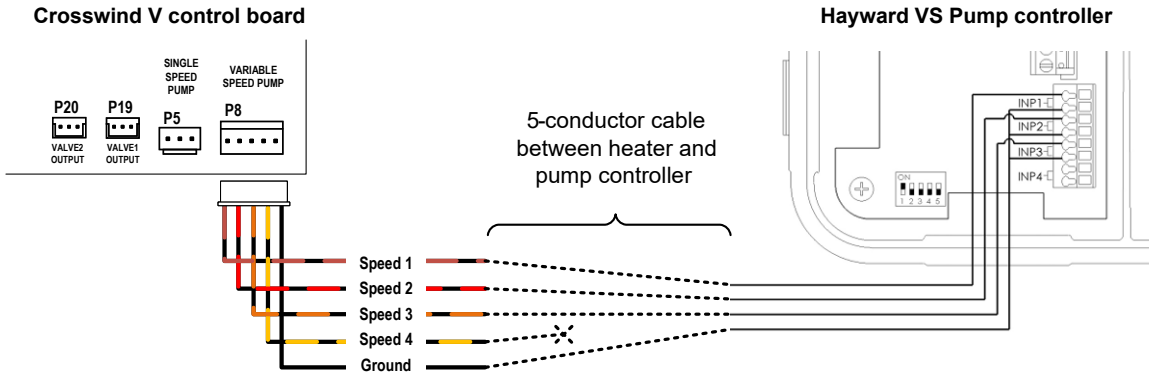

Figure 143. Hayward THP VS Pump Family

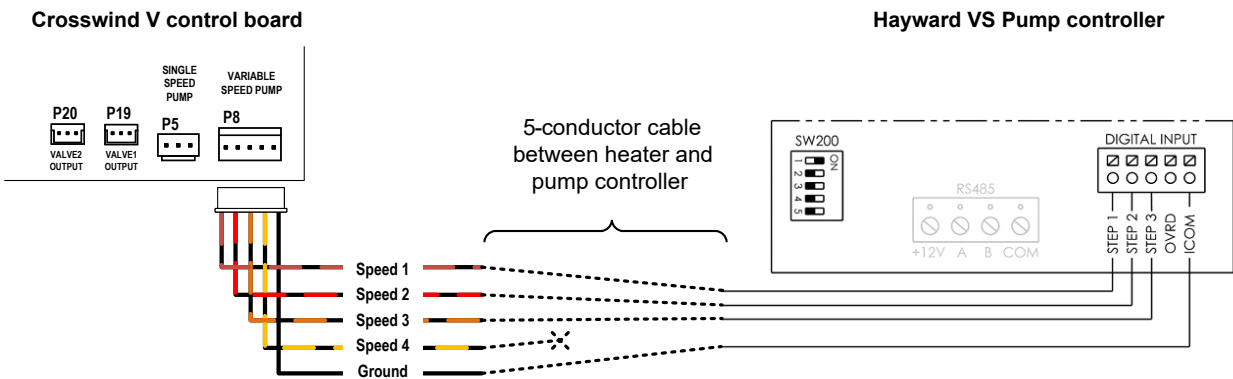

Figure 144. Hayward MaxFlo VS, Super Pump VS and TriStar VS

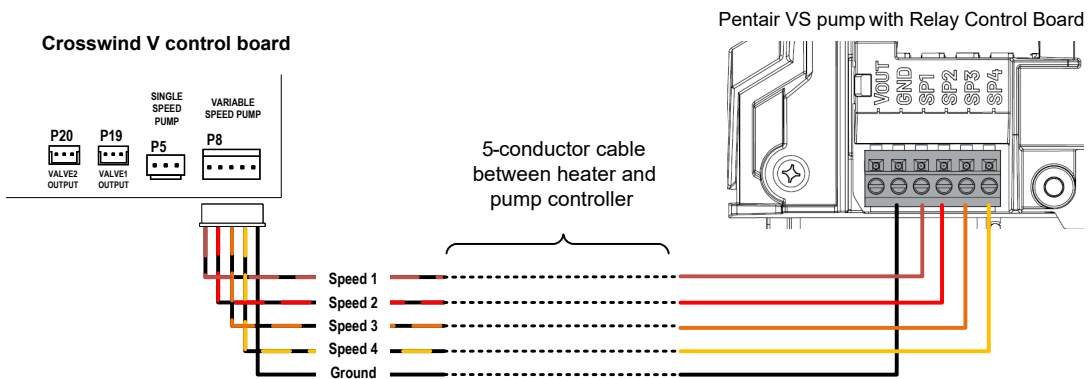

Figure 145. Pentair IntelliFlow and IntelliPro equipped with Relay Control Board

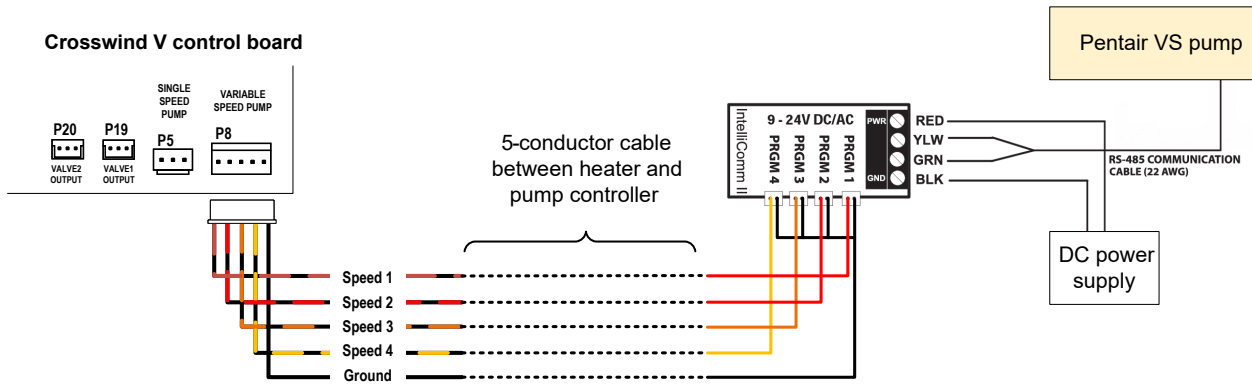

Figure 146. Pentair VS Pumps with IntelliComm II Interface Adapter

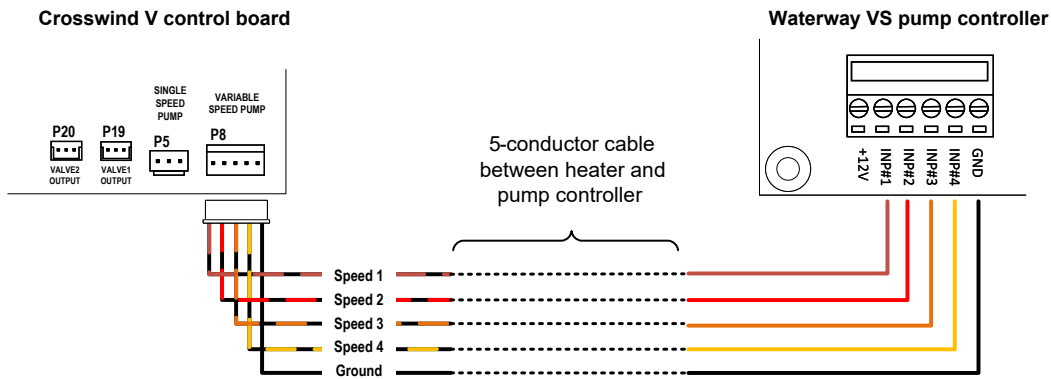

Figure 147. Waterway Power Defender VS Pumps with Discrete Switch Inputs

## Auxiliary Outputs 1 and 2 Wiring

The control is equipped to operate two general-purpose dry-contact relay outputs. The control provides a terminal block with screw connections labeled "AUX 1" and "AUX 2". See Figure 148. Each auxiliary output can independently control one or multiple external devices or electric ON/OFF circuits. These auxiliary relay terminals do not supply voltage and act as power interrupters. Before using these auxiliary outputs, take into account the following considerations:

- Use the auxiliary output to drive power from an external power source to an external device or electric circuit.
- The auxiliary outputs are rated for applications of up to 3 amps. For loads above 3 amps, install a larger relay or contactor in cascade with the auxiliary output.
- Each auxiliary output works as a SPDT relay, providing a Common terminal "C", a Normally Open terminal "NO", and a Normally Closed terminal "NC". Select the proper terminals based on the needs of your application.

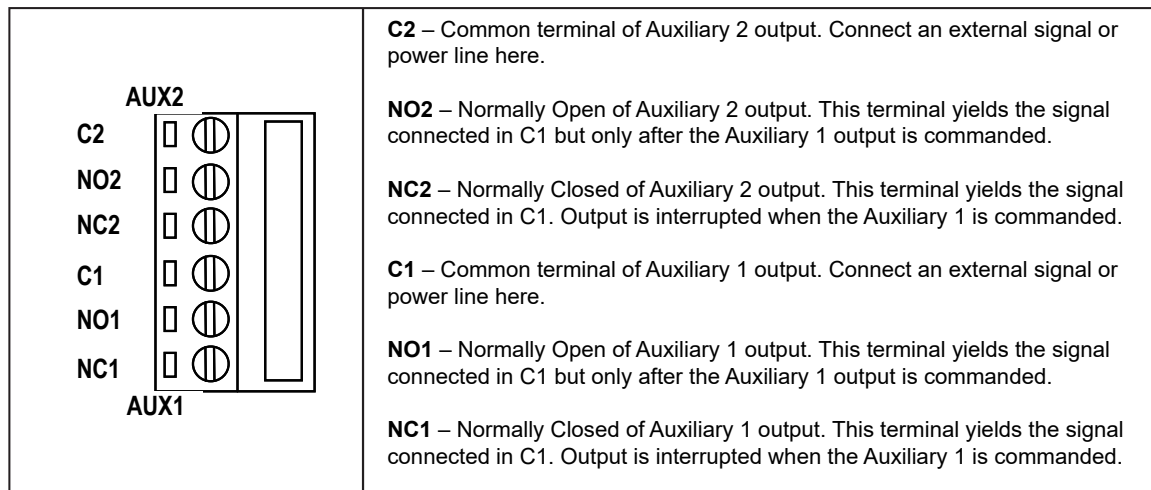

Figure 148. Auxiliary 1 and 2 Outputs



The default setting for Auxiliary Outputs 1 and 2 is to be controlled through the Raymote app using Wi-Fi. To use this mode, the heater must be connected to a local Wi-Fi network in order to manually command the Auxiliaries or run automation routines Online. Alternatively, the Auxiliary outputs can be configured to be controlled by the built-in local schedule, which allows for up to four periods of operation per day, or by the built-in automatic mode "Auxiliary Heat," which commands the auxiliary output to operate an external heater. For more information on the control modes for Auxiliary Outputs 1 and 2, refer to section 13 of the Installer menu on page 21.

1. Determine the power requirements of the external device that will be controlled or energized by the auxiliary output(s).
2. Follow the general instructions for wiring external devices to run the control signal or power line(s) from the power source to the heater control box and from the control box to the device being controlled/energized. Refer to the next examples of external control using the Auxiliary outputs:
  - Controlling pool lights
  - Controlling an air blower
  - Controlling an external heater from the HPPH Auxiliary output.

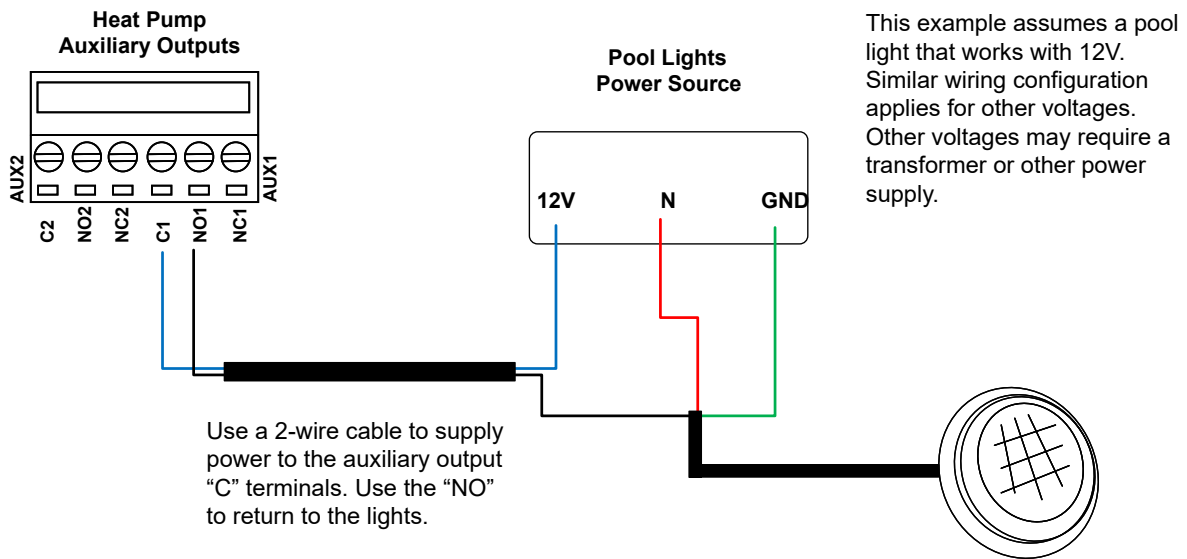

Figure 149. Example 1: Pool Light Wiring

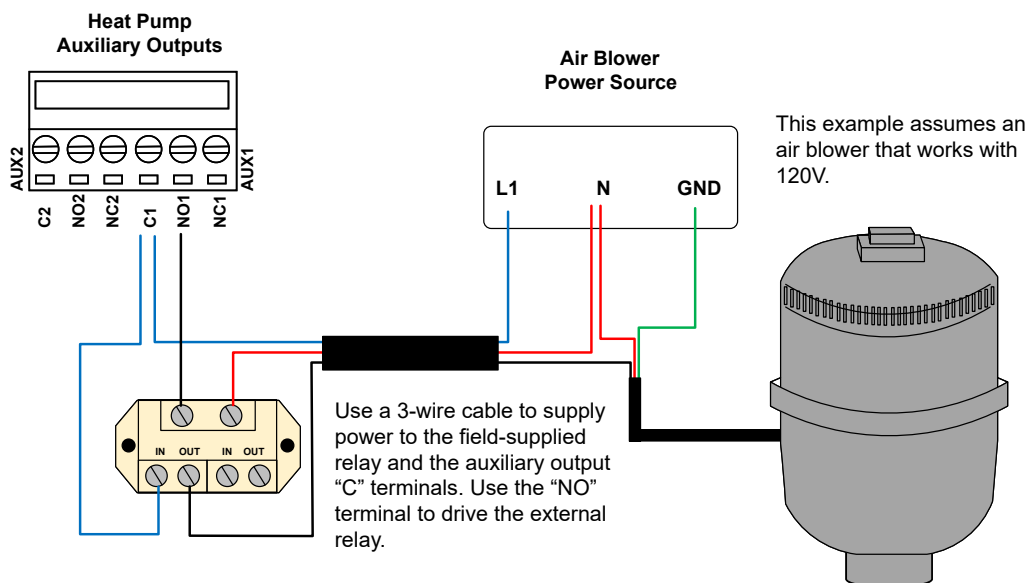
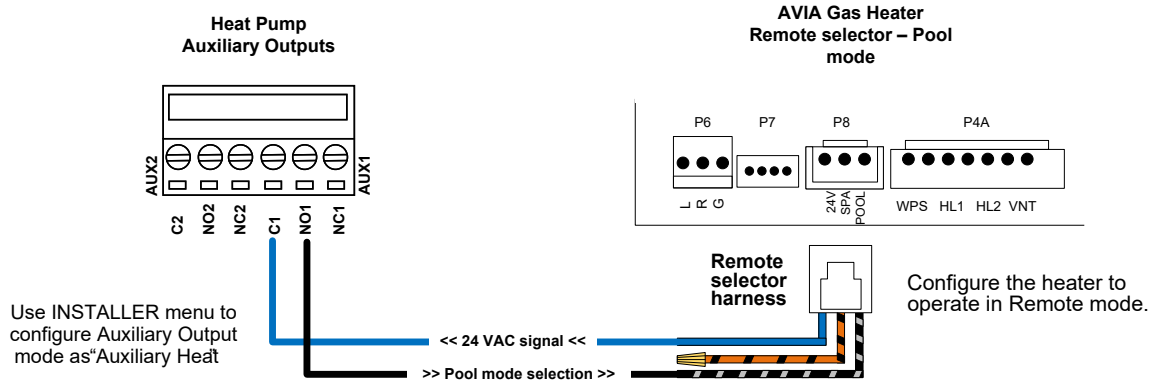
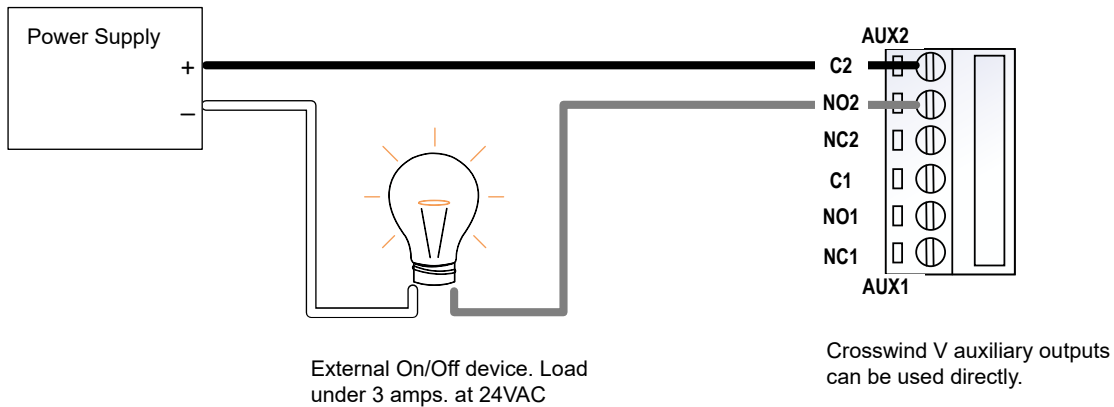

Figure 150. Example 2: Air Blower Wiring

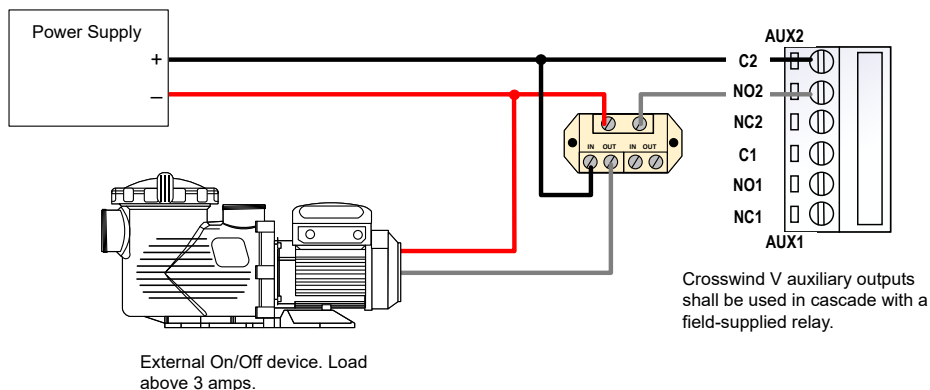

**Figure 151. Example 3: Gas Heater Commanded as Auxiliary Heater**

3. Connect the wires coming from the power source and the external device, following these guidelines. See Figure 152 for further clarification.
  - a. If the application requires less than 3 amps, the terminal block on the Crosswind V control board can be used to drive power to the external device.
  - b. For applications over 3-amps, use a field-supplied relay rated to the amperage and voltage of your application, connected in cascade to the Auxiliary output of the heater. See Figure 153.
4. Ensure that you follow the wire gauge and wire length requirements specified for the external device. Use the appropriate power source for your application. If you are using field-supplied relays, make certain that the coil is rated for the voltage of the external power source.



**Figure 152. Applications Under 3 Amps**



**Figure 153. External Device Wiring to Auxiliary Output**

## Auxiliary Input Wiring

The control is designed to monitor an external signal using the "Auxiliary Input." This input has 24VAC on one terminal and uses the other terminal to receive back the 24VAC to close the auxiliary input circuit. An external "normally closed" safety contactor, such as an emergency stop or an external "disable" signal from an automation controller, can use this auxiliary input. See Figure 154.

By default, the Auxiliary Input is disabled at the factory. You can enable this input to either cause the heater to report the warning fault "Aux Input Warning" on the LCD or to disable the operation of the heater and report the interlock fault "Aux Input Fault." Refer to section 13, Installer menu on page 23 for more information about the Auxiliary Input.

The following steps and wiring diagrams demonstrate the use of the Auxiliary Input with an "Emergency Stop" button that disables the operation of the heater when the Auxiliary Input is configured as "Interlock".

1. Follow the general instructions for wiring external devices by connecting two wires from the "Emergency Stop" button to the heater's control box.

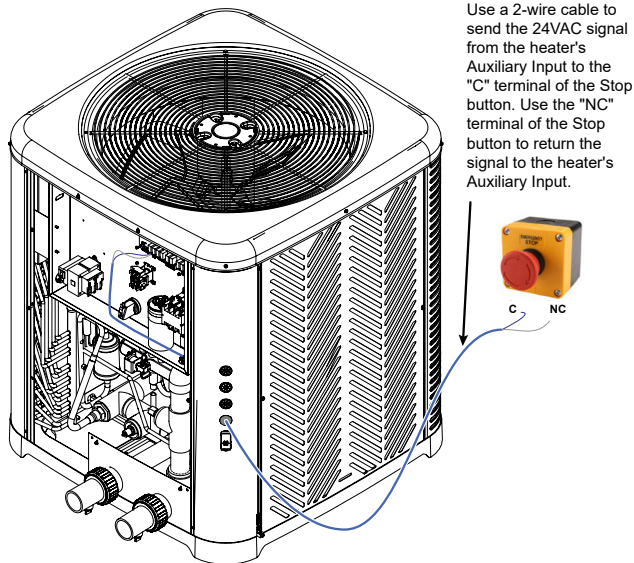

**Figure 154. Cable Routing to the VS Pump Controller**

2. Inside the heater's control box, connect the 2-wire cable to the control board terminal labeled "SOLAR" [P11] using the harness adapter labeled "Solar Temperature Sensor / Auxiliary Safety Input" supplied with the heater in the accessories bag. Make sure to use only the orange wire with black stripes to connect the external safety device. See Figure 155 for details.

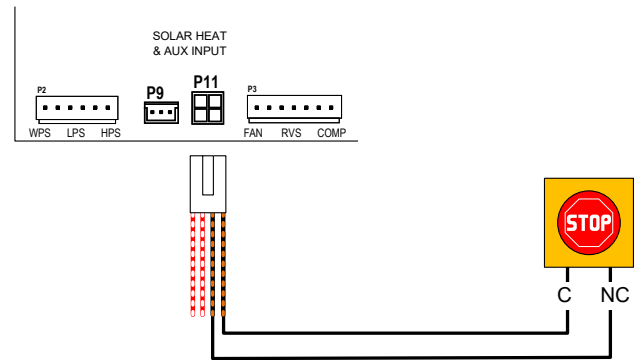

**Figure 155. Auxiliary Input Wiring**

3. Make sure to enable and configure the Auxiliary Input from the INSTALLERS Menu. For detailed information about the Auxiliary Input, refer to section 13, Installer menu on page 23.

## Solar Heater Integration

The control is equipped to function as a solar heater controller integrated with the operation of the heat pump pool heater. It provides a 10K sensor input in P11 and a 3-way valve output in P9 of the control board labeled "SOLAR 3-WAY VALVE." When the "Solar Heating" function is enabled from the Installer Menu, Terminal P9 supplies 24VAC at 0.75 amps to drive a 3-way valve actuator. Terminal P11 provides an input to connect a 10K thermistor to be used as a 'Solar sensor.' Please note that the 10K solar sensor is not included with the heater. You can order a 'Temp Sensor 10K' spare sensor (service PN 100-10001050 - KIT - HPPH Sensor Solar 10K) to use as the Solar sensor.

By default, the "Solar Heating" function is disabled at the factory. You can enable this function from the Installer Menu and configure it to operate a Solar Heating collector simultaneously with the Crosswind V Heat Pump Pool Heater. For detailed information about configuring the Solar Heating function, refer to section 13 (Installer Menu) on page 21.

The following steps and wiring diagrams describe the expected installation of the Solar heater components in the pool piping.

1. The 10K "Solar sensor" should be installed before the solar 3-way valve. The ideal position is between the pump and the filter.
2. Install a "Solar 3-way valve" downstream of the filter to divert water flow to either the Heat Pump or Solar collector when commanded. The default flow position should be directed towards the Heat Pump.
3. Install a "check valve" at the outlet of the solar heater to prevent backflow to the solar collector. See Figure 156.

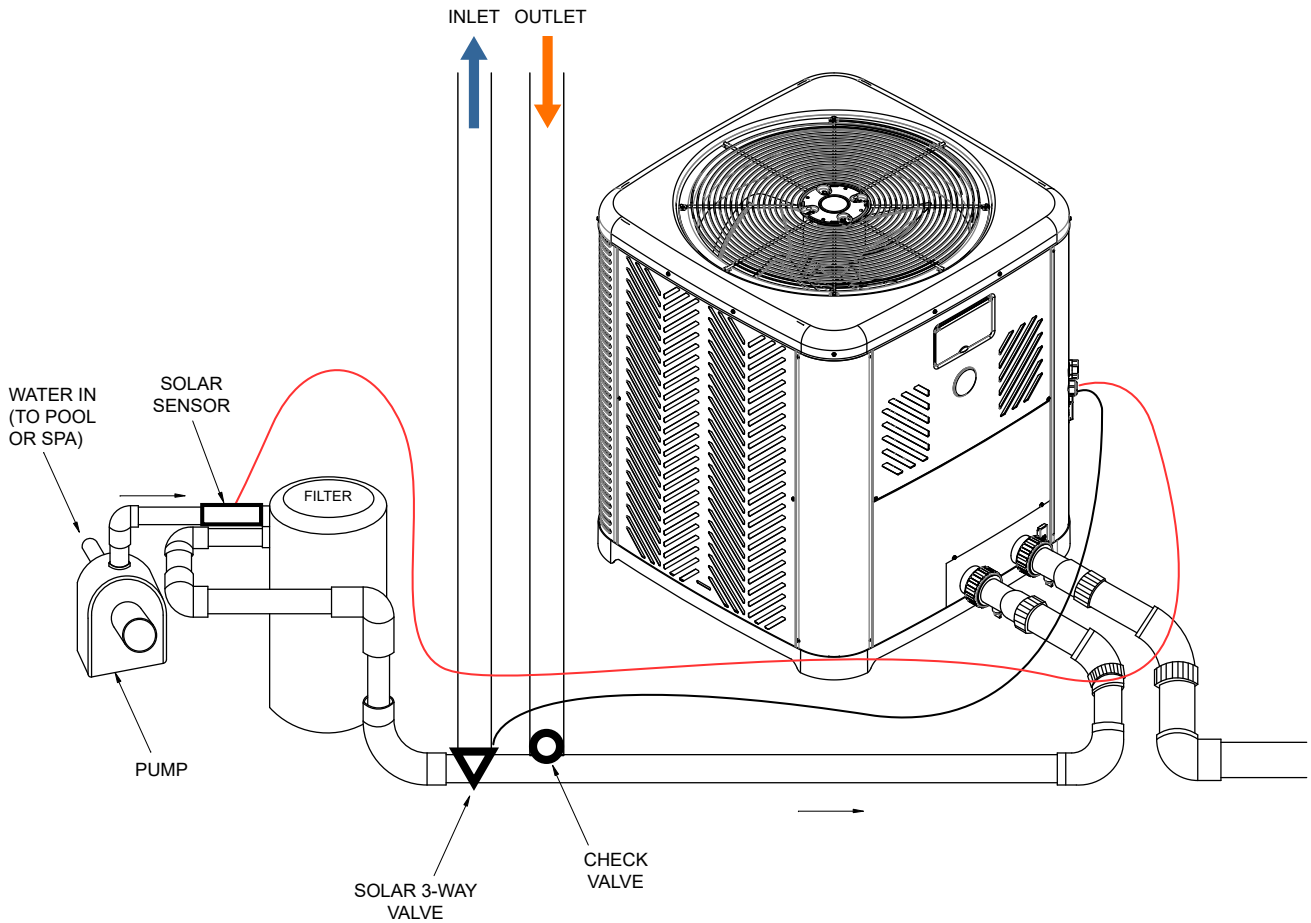

Figure 156. Solar Heater Components in the Piping

4. Follow the general instructions for wiring external devices and route the wires for the "Solar sensor" and "Solar 3-way valve" to the control box of the heater.
5. Inside the control box of the heater, connect the wires for the "Solar sensor" to the control board terminal labeled as "SOLAR" [P11] using the harness adapter labeled as "Solar Temperature Sensor / Auxiliary Safety Input" provided in the accessories bag. Connect the Red with White wires for a 10K temperature sensor and use the terminal [P9] to connect a standard 3-way valve actuator for the "Solar 3-way valve". Refer to Figure 157 for details.
6. Enable the "Solar Heating" option and configure the necessary parameters based on your system requirements and operation preferences from the Installer menu. Refer to section 13 in page 21 for further details on configuring the Solar Heating function.

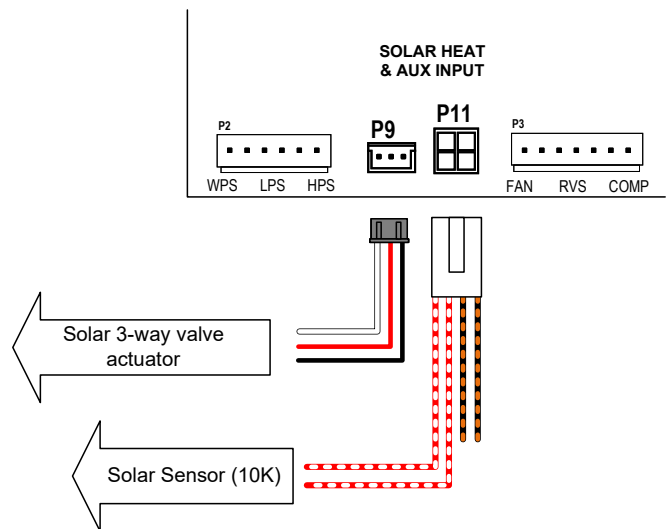

Figure 157. Solar Heat & Auxiliary Input

## Water Flow Switch (WFS) Wiring

The WFS comes with a limited wire length. Extend the wires as required, ensuring they do not exceed 20 ft. in length.



Figure 158. Water Flow Switch

- Before starting any work on the heater, make sure to shut off all power to avoid the risk of electrical shock or damage to components.
- Ensure to run the WFS wires separately from the high-voltage wires. Low-voltage wiring should not be run together with high-voltage lines.

Follow the next set of instructions to connect the WFS to the heater.

1. After installing the WFS onto the heater's inlet pipeline, route the wires from the WFS to the heater's corner post. See Figure 65.
2. Use the grommet/knockouts located on the heater's corner post to route WFS wires into the heater. Ensure that liquid-tight connectors are used to prevent water or dust intrusion. See Figure 65.
3. To access the heater's front control cover panel, use a 1/4" hex head screwdriver to unscrew the six (6) screws. See Figure 127.
4. To remove the front panel, pull the bottom of the panel downward and outward, and then disconnect the wire attached to the rear of the user interface. See Figure 128.
5. The panel should now be free for removal. See Figure 128.
6. Set the control panel cover aside to reinstall when wiring is completed.
7. Use the grommets in the control box to run wires from inside the corner post to the inside of the electrical junction box, using the grommets located next to the transformer. See Figure 159.
8. Locate the orange wires connected to the Water Pressure Switch (WPS). Proceed to disconnect the terminals from the WPS. See Figure 159.
9. Connect the 2-wires from the WFS with the 2 orange wires that were disconnected from the WPS.

- a. For a clean installation, use 1/4" male spade terminals (.032 x .250, 18-22 AWG) for each wire of the WFS to mate with the WPS orange female terminal wires.
  - b. Alternatively, connect the WPS orange wires with the WFS wires using wire nuts or butt splices.
10. Reinstall the control panel. Ensure to reconnect the display board before fastening the front panel.

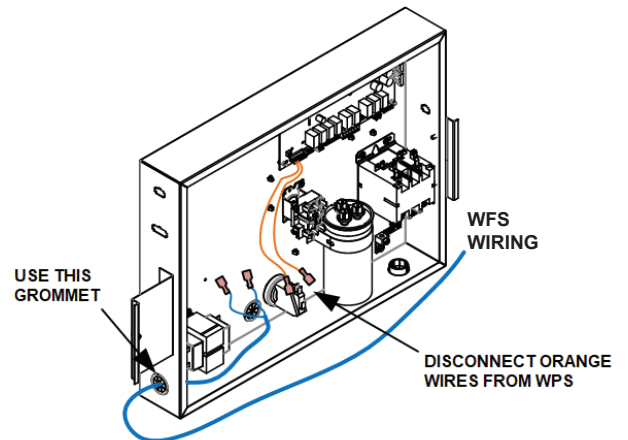

Figure 159. WFS Wire Routing into J-Box

## 28. REPLACEMENT PARTS

**NOTE:** To supply you with the correct part, it is important that you supply the heater model and serial number.

Any part returned for replacement under standard company warranties must be properly tagged with a return parts tag, completely filled in with the heater serial number, model number, etc., and shipped to the Company freight prepaid.

If determined defective by the Company and within warranty, a like part or equal substitution will be returned, freight collect. Credit will not be issued.

### **MANUFACTURER:**

**Av. New York 207, Parque Industrial Oradel, C.P.  
88285 Nuevo Laredo Tamps. Mexico**

# 29. ILLUSTRATED PARTS LIST

## MODELS 4550-8550

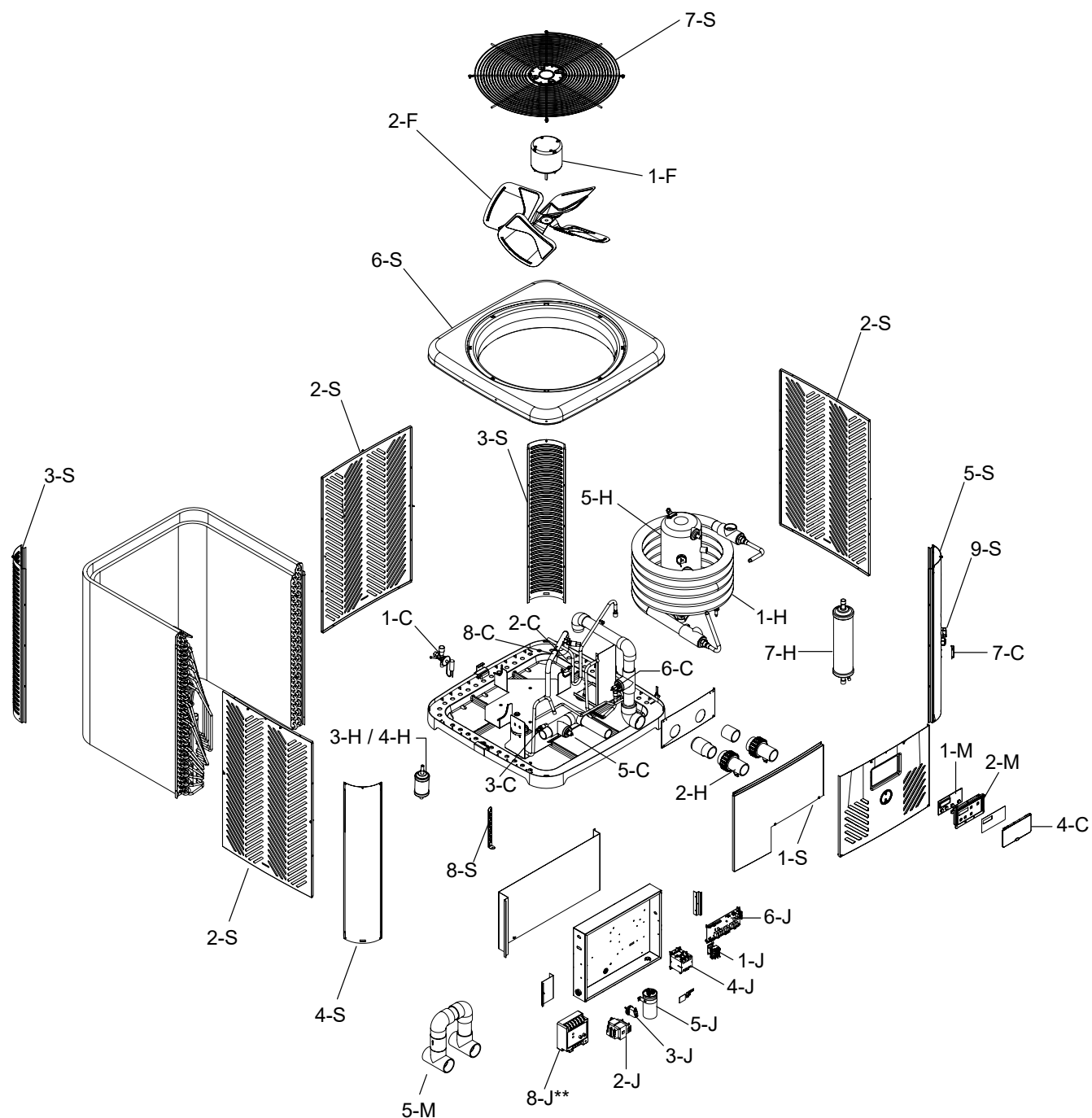

CALL OUT	DESCRIPTION	4550	5550	6550	8550
<b>C</b>	<b>CONTROLS</b>				
1-C	TX Valve	100-10000385	100-10000386	100-10000386	100-10000387
2-C	Low Pressure Switch	100-10000633	100-10000633	100-10000633	100-10000633
3-C	High Pressure Switch	100-10000634	100-10000634	100-10000634	100-10000634
4-C	Control Cover	100-10000388	100-10000388	100-10000388	100-10000388
5-C	Inlet Temp Sensor 100K	100-10000635	100-10000635	100-10000635	100-10000635
6-C	Outlet Temp Sensor 10K	100-10000636	100-10000636	100-10000636	100-10000636
7-C	Ambient Temp Sensor	100-10000637	100-10000637	100-10000637	100-10000637
8-C	Coil Defrost Sensor	100-10000643	100-10000643	100-10000643	100-10000643
9-C	Harness Assy J-Box	100-10000394	100-10000394	100-10000394	100-10000394
10-C	Harness Assy/Fan	100-10000396	100-10000396	100-10000396	100-10000396
11-C	Harness Assy Contactor	100-10000397	100-10000397	100-10000397	100-10000397
12-C	Harness Assy Rev Valve/Press Switches	100-10000398	100-10000398	100-10000398	100-10000398
13-C	Harness Assy-Temp Sensor	100-10000399	100-10000399	100-10000399	100-10000399
14-C	Harness Reversing Valve Connector*	100-10000644	100-10000644	100-10000644	100-10000644
15-C	Variable-Speed Pump Harness	100-10000690	100-10000690	100-10000690	100-10000690
16-C	Single-Speed Pump Harness	100-10000689	100-10000689	100-10000689	100-10000689
17-C	Solar Sensor and Aux Safety Harness	100-10000688	100-10000688	100-10000688	100-10000688
18-C	3-wire Remote Harness adapter	100-10001036	100-10001036	100-10001036	100-10001036
19-C	Kit - HPPH Sensor Solar 10K	100-10001050	100-10001050	100-10001050	100-10001050
<b>H</b>	<b>HEAT TRANSFER</b>				
1-H	Heat Exchanger	H000278	H000368	H000368	H000369
2-H	PVC Union	H000317	H000317	H000317	H000317
3-H	Liquid Line Drier	H000188	H000011	H000011	H000011
4-H	Liquid Line Drier (EHC models) *	NA	NA	H000004	H000004
5-H	Compressor R-410A 208/230V 1PH 60Hz	100-10000400	H000348	H000012	H000014
6-H	Compressor Power Plug (Not Shown)	H000271	H000271	H000271	H000271
7-H	Charge Compensator	NA	NA	NA	H000255
8-H	Reversing Valve * (Not Shown)	NA	NA	H000136	H000136
<b>F</b>	<b>FAN</b>				
1-F	Fan Motor	100-10000638	100-10000638	100-10000638	100-10000638
2-F	Fan Blade	100-10000639	100-10000639	100-10000639	100-10000639
<b>J</b>	<b>CONTROL BOX</b>				
1-J	Fan Relay	H000299	H000299	H000299	H000299
2-J	Transformer	100-10000640	100-10000640	100-10000640	100-10000640
3-J	Water Pressure Switch	H000025	H000025	H000025	H000025
4-J	Contactora	H000043	H000043	H000043	H000043
5-J	Capacitor	H000051	H000051	H000051	H000051
6-J	Control Board Digital	100-10000389	100-10000389	100-10000389	100-10000389
7-J	Fuse (Not Shown)	H000370	H000370	H000370	H000370
8-J	Monitor**	H000291	H000291	H000291	H000291
<b>M</b>	<b>MISCELLANEOUS</b>				
1-M	PC Board Display	100-10000390	100-10000390	100-10000390	100-10000390
2-M	Bezel Gasket	100-10000391	100-10000391	100-10000391	100-10000391
3-M	UI Harness (Not shown)	100-10000393	100-10000393	100-10000393	100-10000393
4-M	Touch-up Paint (Not Shown)	100-10000401	100-10000401	100-10000401	100-10000401
5-M	Water Bypass	100-10000816	100-10000816	100-10000816	100-10000816
6-M	Water Flow Switch (Not Shown)	H000166	H000166	H000166	H000166
<b>S</b>	<b>SHEET METAL</b>				
1-S	Access Panel	100-10000402	100-10000402	100-10000402	100-10000402
2-S	Side Panel	100-10000403	100-10000403	100-10000403	100-10000403
3-S	Corner Louver Panel	100-10000404	100-10000404	100-10000404	100-10000404
4-S	Corner Solid Panel	100-10000405	100-10000405	100-10000405	100-10000405
5-S	Corner Plug Holes Panel	100-10000406	100-10000406	100-10000406	100-10000406
6-S	Jacket Top	100-10000407	100-10000407	100-10000407	100-10000407
7-S	Grille Fan Guard	100-10000641	100-10000641	100-10000641	100-10000641
8-S	Hurricane Bracket HT Pump SS	H000357	H000357	H000357	H000357
9-S	Sensor Cover	H000362	H000362	H000362	H000362

\*EHC models only.

\*\*8-J Monitor is optional on voltage monitor models.

**NOTE:** Items 9-C through 19-C are not shown in the IPL illustration because they are part of the unit's wiring.



## NOTES

---