

99-55-4370000  
INSTRUCTIONS

# DELUXE RESIN REEL SYSTEM FOR ABOVE GROUND POOLS

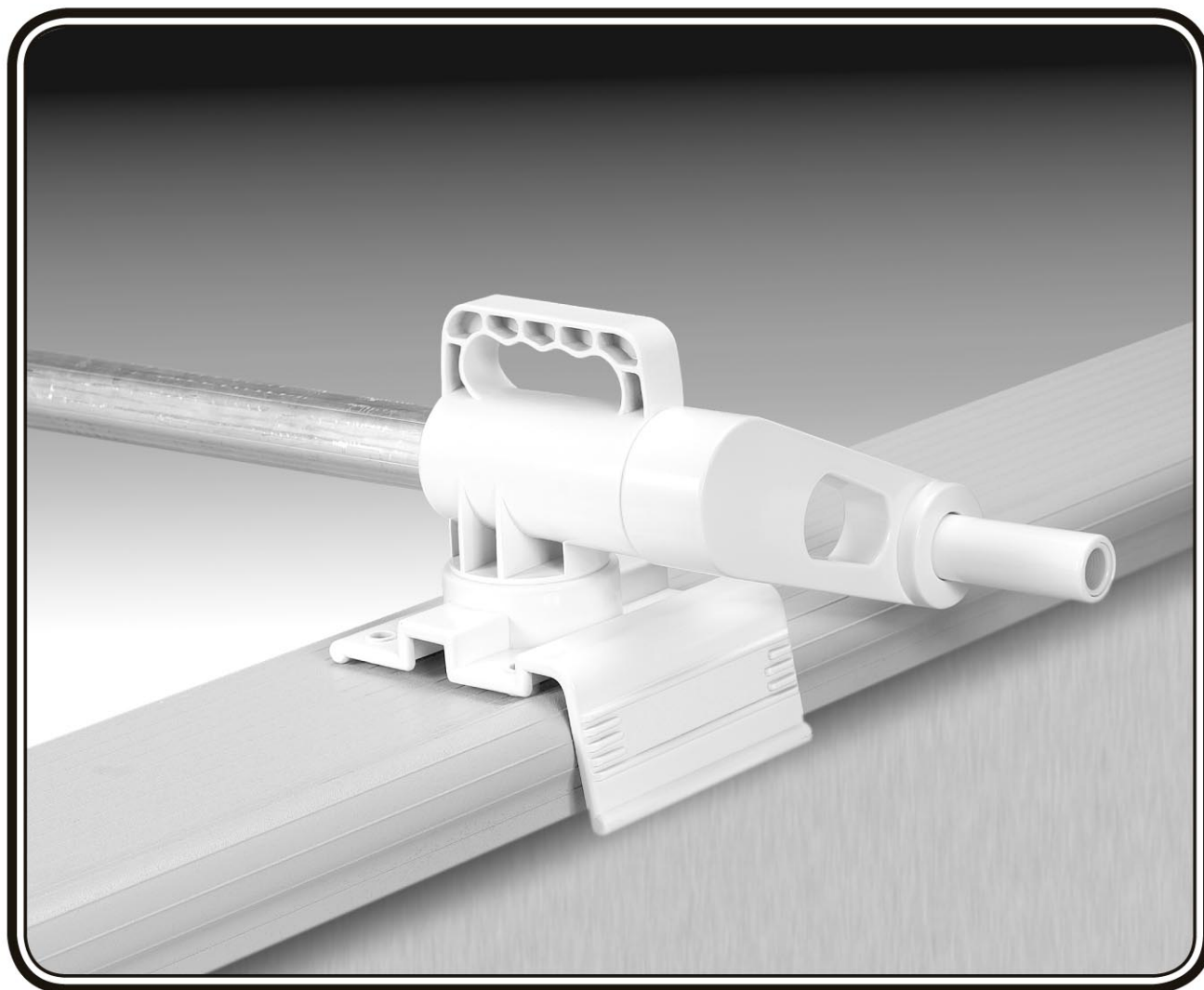

REGISTER WARRANTY ONLINE AT [WWW.GLIPOOLPRODUCTS.COM](http://WWW.GLIPOOLPRODUCTS.COM).  
*PLEASE REGISTER WITHIN 10 DAYS OF PURCHASE.*

IF YOU WISH TO MAKE A CLAIM, CALL TOLL FREE 1-800-448-2343.  
FOR REPLACEMENT PARTS FOR YOUR REEL SYSTEM PLEASE VISIT, [WWW.GLIPROMOTIONS.COM](http://WWW.GLIPROMOTIONS.COM).







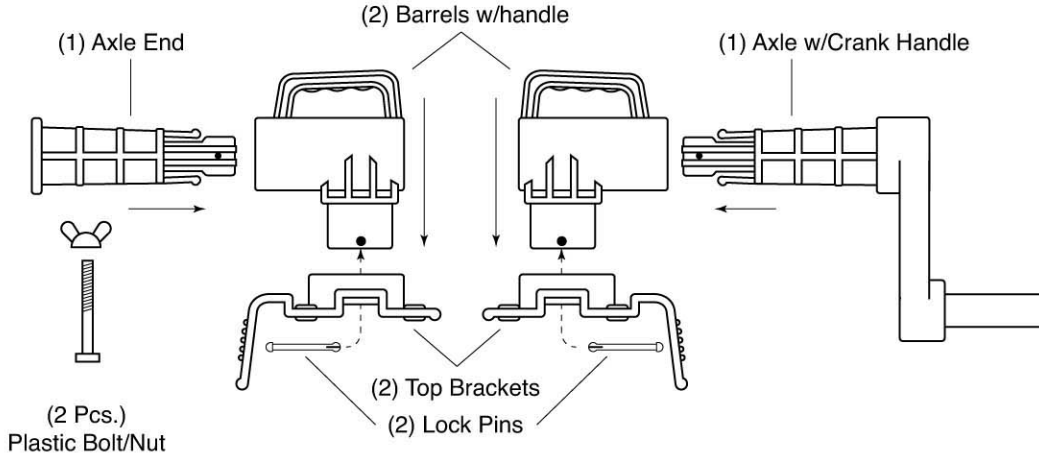

Youngstown, Ohio 44510 • [www.glipoolproducts.com](http://www.glipoolproducts.com)

## INSTALLATION INSTRUCTIONS

1. **CONGRATULATIONS** on your purchase of our Deluxe Solar Reel for Above Ground Pools. Please follow the instructions carefully so as to not void warranty.
2. Please use your solar blanket and reel assembly in the manner it was intended for:
  - a. Your solar blanket is not a safety cover
  - b. Remove the solar blanket and Solar Reel™ assembly from the pool completely before swimming use.
  - c. Do not store the solar blanket on the ground in direct sunlight, as it will burn the lawn
3. Preparation & Assembly: Check inventory of all items and assemble as illustrated below:



PARTS BREAKDOWN			
PART NUMBER	DESCRIPTION	QUANTITY	
1	99-55-4375000	Axle with Crank Handle	1
2	99-55-4375001	Axle End	1
3	99-55-4375002	Barrels with Handle	2
4	99-55-4375003	Mounting Brackets	2
5	99-55-4375004	Plastic Lock Pins (IN STRAP KIT)	2
6	99-55-4395014	Bumpers (IN STRAP KIT)	4
7	99-55-4375005	1.57" Axle bolt (IN STRAP KIT)	2
8	99-55-435006	AG Strap Kit	1

STRAP KIT	
	(9 Pcs.) Plastic Screw (1 extra piece)
	(17 Pcs.) Plastic Strap Plate (1 extra piece)
	(10 Pcs.) Stainless Steel Self-Drilling Screws (1 extra piece)
	(1 Pc.) Driver Bit
	(8 Pcs.) Stainless Steel Philips Head Screw
	(1 Pc.) Philips Driver Bit
	(8 Pcs.) Fabric Straps (1 extra piece)

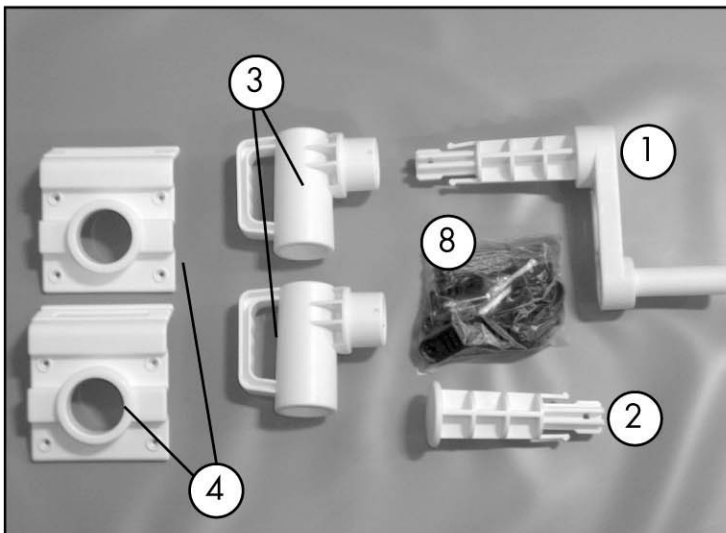

4. Depending upon the size of your pool you will also require one of the following tube kits: (Tube Assembly is detailed below)

AGR4370018 - 18' AGR TUBE KIT  
(3) 57" x 1.5" Diameter Inner Tube  
(2) 57" x 1.7" Diameter Outer Tube  
(25) #410 SS Self Drilling Screw

AGR4370024 - 24' AGR TUBE KIT  
(3) 66" x 1.5" Diameter Inner Tube  
(2) 66" x 1.7" Diameter Outer Tube  
(25) #410 SS Self Drilling Screw

AGR4370030 - 30' AGR TUBE KIT  
(4) 59.5" x 1.5" Diameter Inner Tube  
(3) 59.5" x 1.7" Diameter Outer Tube  
(37) #410 SS Self Drilling Screw

5. Positioning Your Solar Reel:

For Rectangular pools, place top-rail brackets at either end of pool. (Fig. A)

For Oval pools, place top-rail brackets at either end of pool where radius begins. (Fig. B)

For Round pools, place top-rail brackets at center of pool. (Fig. C)

Fig. A

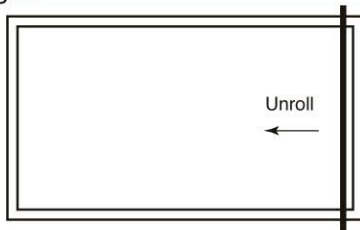

Fig. B

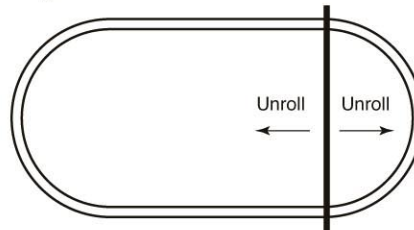
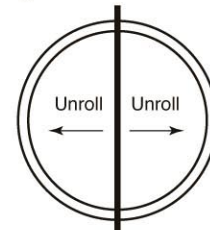

Fig. C



6. Trimming Your Solar Blanket:

- Lay your Solar Blanket (not provided) on top of water. **IMPORTANT!** Oval & Round Pool owners will need to fold their solar covers at point of placement of brackets! The cover will unroll left and right of brackets & cross pole. Please allow 6 inches more material on length to allow for a fold where straps will be attached for wind onto reel system. (See Illustrations above)
- With scissors trim blanket to fit shape of pool. Be sure to clear the inside top rail of pool.

7. Permanently Mounting Your Solar Reel Brackets:

- At some point, you may decide to permanently mount top rail brackets to the top rail of the pool. This creates a handy "Socket" to accept your Solar Reel Crank & Barrel. You can permanently mount brackets at any time once you have developed a confidence level in the correct positioning and assembly of all parts. If mounted to top rail, you do not need the lock pin that holds barrel to top plate. Brackets are attached to top rail through the four countersunk holes in the rail brackets. Exercise caution before drilling any holes in your pool top rail to avoid damaging wall or liner. Lock Pins can be installed or removed by tapping in or out with a punch and hammer. (See Illustrations)

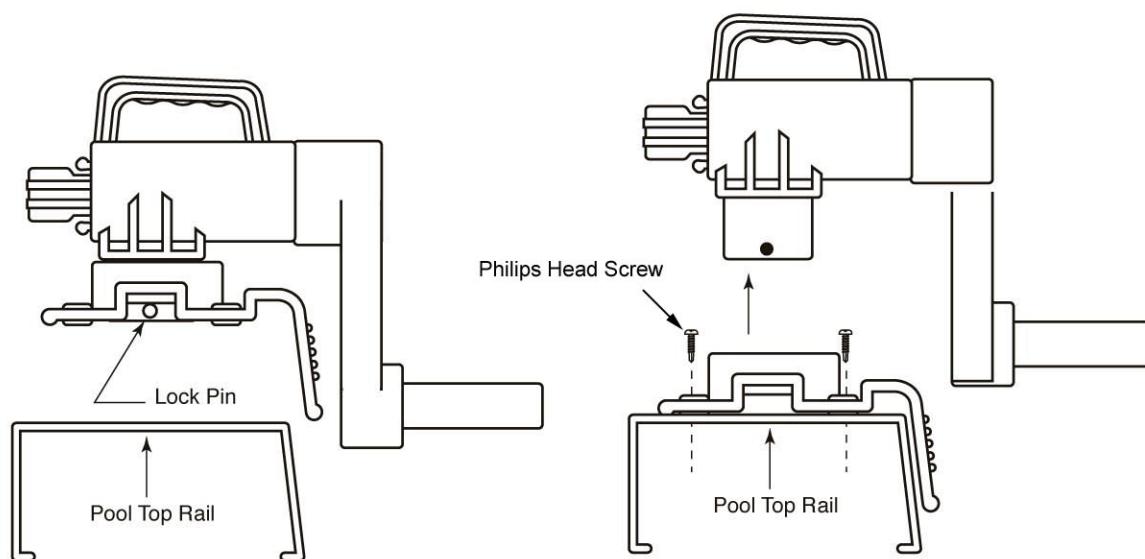

**NON-PERMANENT ASSEMBLY**

**SOCKET STYLE ASSEMBLY**



## 8. Assembling The Tube Kit:

All Tube Kits consist of 6 sided Hexagon shaped aluminum tubing. There are two sizes, of tubing 1.5" and 1.7", the smaller size nesting into the larger size. The smaller tubes are always the end tubes. The end tubes are sized to fit on the Crank and Axle End at either side of the pool. You will use a series of pre-drilled holes, spaced approximately 1.5" and 7.5" inches from each end to join the large tubing to the small tubing. These holes are space 120 degrees apart. At appropriate time you will secure with self-drilling and taping SS screws. Also take note of large holes that pierce both end tubes. You will eventually use these holes to anchor tubing to Crank Axles with bolts provided.

- Loosely assemble extruded tubes together. Slide excess width into adjoining tubes, dividing it up as equally as possible.  
**Note: You must have a minimum of 9" of overlap in each tube!**
- Measure the width across the pool from barrel to barrel and add approximately 1.5" to the total.
- Adjust the total length of the tube assembly to fit the span plus the 1.5" inches.
- Lock the tubes together by rotating each adjoining tube in the opposite direction. (See illustrations)
- Secure each tube with just 1 self drilling screw in each adjoining tube.
- Attach the tube assembly into the barrels and check for fit.
- When all is OK drill and screw the remaining screws at each end of the overlapped poles. You should have 6 screws on each tube end where there is a connection.
- Assemble Tube assembly together with Barrels by lining up hole in the end of each tube fitted into barrel and secure with SS axle bolt and nut provided.

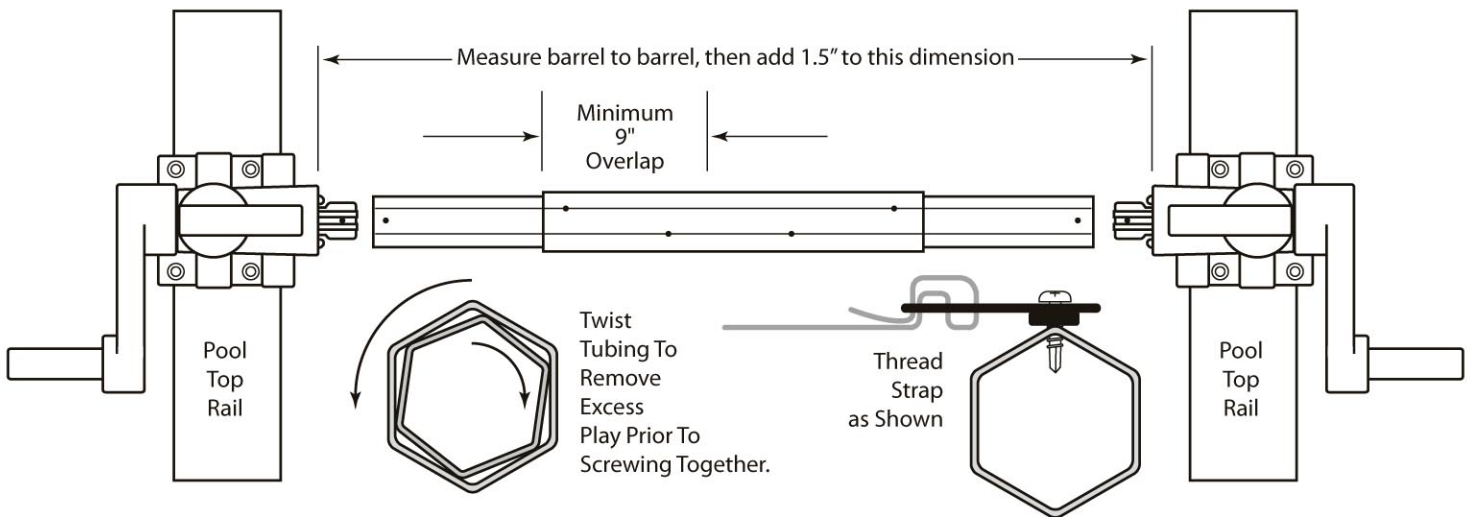

9. Attach Straps to Tubes: Come in 6 inches from each tube end and attach a strap plate to the aluminum tube assembly. Use the self drilling screws on the drill line to attach the plate. Look at the holes that were pre-drilled at the factory and use the same drill line. There are 6 lines on each tube. Take the remaining strap plates and connect them evenly along the length of the tube assembly. Attach Straps to strap plate. (See Illustration Above Right)

10. Attach Solar Blanket to Straps: If reel is to be located at the end of the pool, attach cover to strap plate with plastic screw as shown in Illustration Below Left. If reel is to be located offset or at the center of the pool then attach cover to strap plate forming a fold to act like a hinge and the plastic screw will go through two layers of the solar blanket as shown in Illustration Below Right. Bubbles should face down.

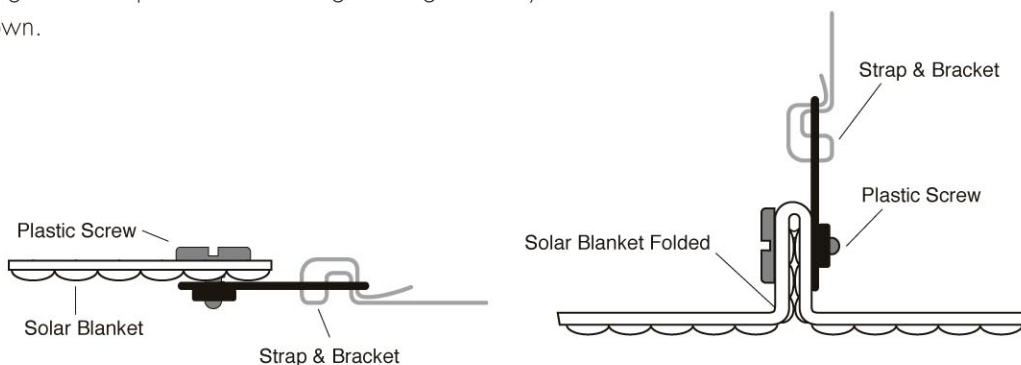

**GLI**  
Pool Products

Youngstown, Ohio 44510 • www.glipoolproducts.com