

# STEP OPTIONS

## STEP OPTION 1

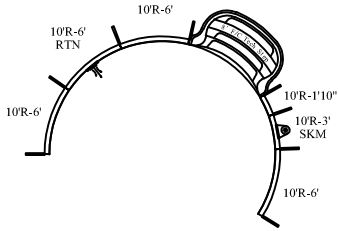

## STEP OPTION 2

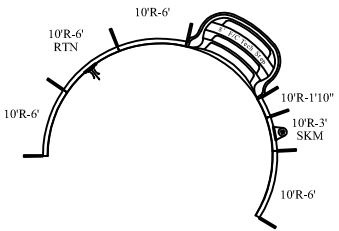

## STEP OPTION 3

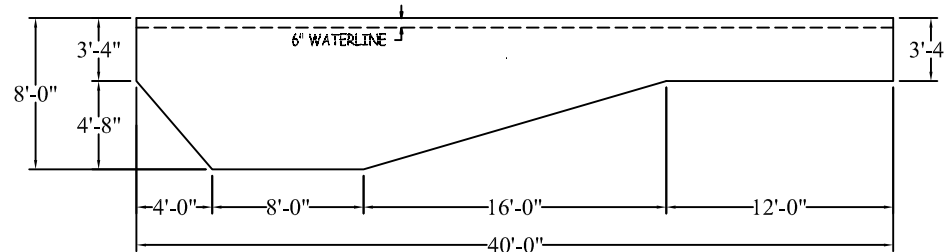
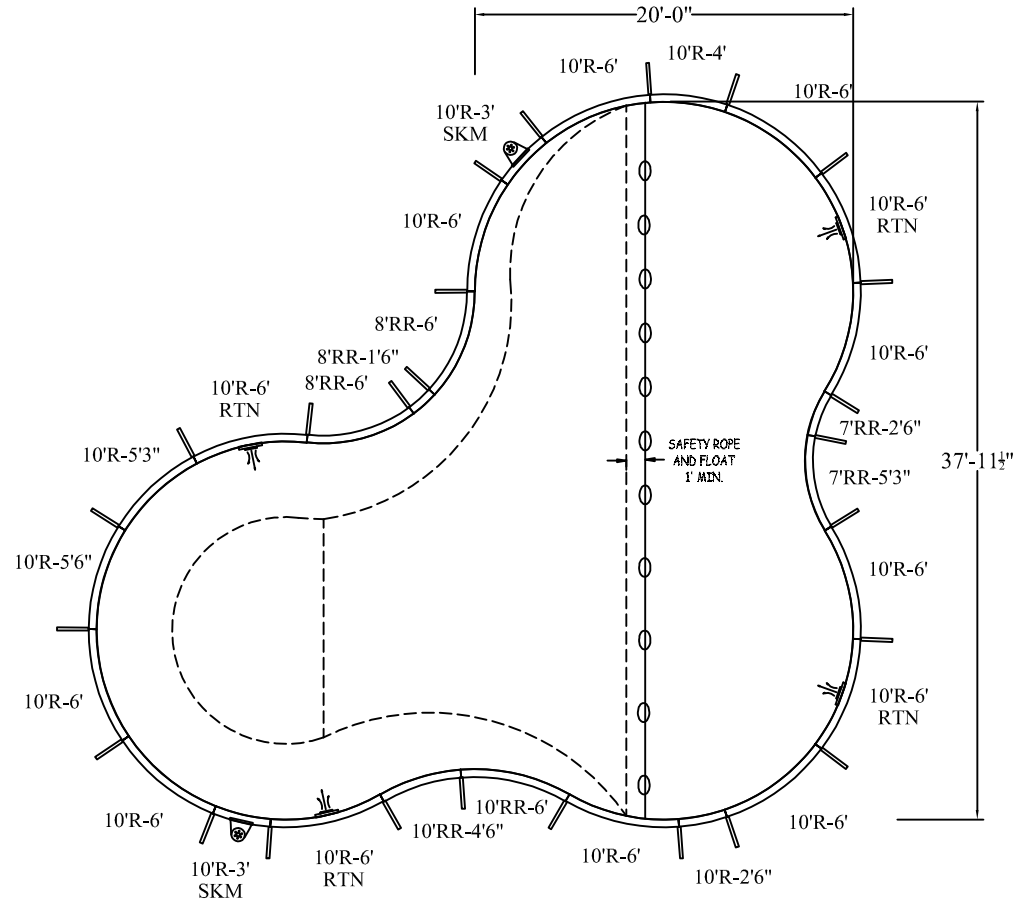
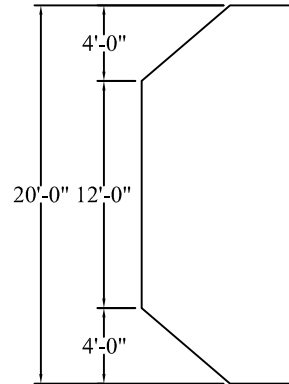
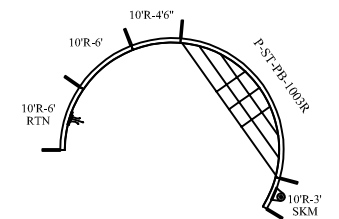

LAGOON

DATE: 01/01/2019

PERIMETER: 133'-0" LIN.FT.

REVISION:

SURFACE (ft²): 1016.2184

SCALE: N.T.S.

LINER (ft²): 1159.1660

APPROX. WATER VOLUME: 121 300 LITRES

COVER (ft²): 1403.0000 FREEFORM

# ATLAS SERIES

### WARNING

SWIMMING POOLS ARE DANGEROUS WHEN USED IMPROPERLY. CONSULT YOUR DEALER FOR INFORMATION ON THE SAFE USE OF SWIMMING POOLS. IT IS THE RESPONSIBILITY OF TOWN OFFICIALS, BUILDERS AND HOME OWNERS TO FOLLOW ALL SAFETY RECOMMENDATIONS OF LOCAL ORDINANCES AND EQUIPMENT MANUFACTURERS FOR DIVING & SLIDING EQUIPMENT REFER TO THE MANUFACTURER'S INSTRUCTIONS TO CORRECTLY POSITION & INSTALL EQUIPMENT.

20-0 X 38-0 X 40-0 RIGHT

	A	B	C	D
1	32'-3 1/4"	43'-10 1/2"	34'-2 1/2"	16'-11 3/4"
2	43'-10"	32'-3 1/2"	17'-0"	34'-2"
3	34'-2"	17'-0"	32'-3 1/2"	43'-10"
4	18'-5 3/4"	32'-4 1/2"	42'-4 1/2"	33'-0"
5	50'-11 1/2"	21'-1 1/2"	21'-1 1/2"	50'-11 1/2"
6	52'-1 3/4"	52'-2"	22'-8"	22'-7 1/2"
7	23'-11 1/4"	36'-10 1/4"	37'-11"	25'-6 3/4"
8	25'-1"	25'-1 1/2"	37'-1 3/4"	37'-1 1/4"
9	44'-0 1/4"	17'-8"	24'-11"	47'-4 3/4"
10	47'-5"	24'-11 1/4"	17'-7 3/4"	44'-0 1/4"
11	47'-1 1/2"	42'-2 1/2"	17'-4 1/2"	27'-2 1/2"
12	42'-2 1/4"	47'-2"	27'-3 1/4"	17'-3 3/4"
S1	30'-1"	14'-2 1/2"	42'-2"	49'-9 3/4"
S2	49'-9 3/4"	42'-2"	14'-2 1/2"	30'-1"
H1	24'-5 3/4"	36'-1 1/2"	37'-2"	25'-11 3/4"
H2	42'-1 3/4"	49'-10"	30'-1 1/2"	14'-2"
A	-	44'-0 1/2"	60'-10"	41'-11 1/2"

DIAGONALS		2 to 4	25'-4 1/2"	3 to 12	30'-6 3/4"
1 to 2	20'-0"	2 to 5	17'-0"	4 to 5	33'-7 3/4"
1 to 3	26'-10 1/2"	2 to 6	20'-0"	4 to 6	36'-1 1/4"
1 to 4	18'-0"	2 to 7	21'-4"	4 to 7	8'-0"
1 to 5	35'-7"	2 to 8	20'-6"	4 to 8	8'-0"
1 to 6	20'-0"	2 to 9	15'-2 3/4"	4 to 9	27'-0"
1 to 7	10'-0"	2 to 10	10'-0"	4 to 10	29'-4"
1 to 8	20'-6"	2 to 11	10'-0"	4 to 11	29'-6 3/4"
1 to 9	31'-2"	2 to 12	17'-4"	4 to 12	26'-8 3/4"
1 to 10	28'-11 3/4"	3 to 4	18'-0"	5 to 6	35'-10 3/4"
1 to 11	17'-3 3/4"	3 to 5	17'-0"	5 to 7	33'-4"
1 to 12	10'-0"	3 to 6	36'-8"	5 to 8	26'-0"
2 to 3	17'-11 1/2"	3 to 7	20'-6 1/4"	5 to 9	7'-0"
		3 to 8	10'-0"	5 to 10	7'-0"
		3 to 9	10'-0"	5 to 11	26'-3"
		3 to 10	15'-3"	5 to 12	34'-4"
		3 to 11	27'-1"	6 to 7	28'-8"

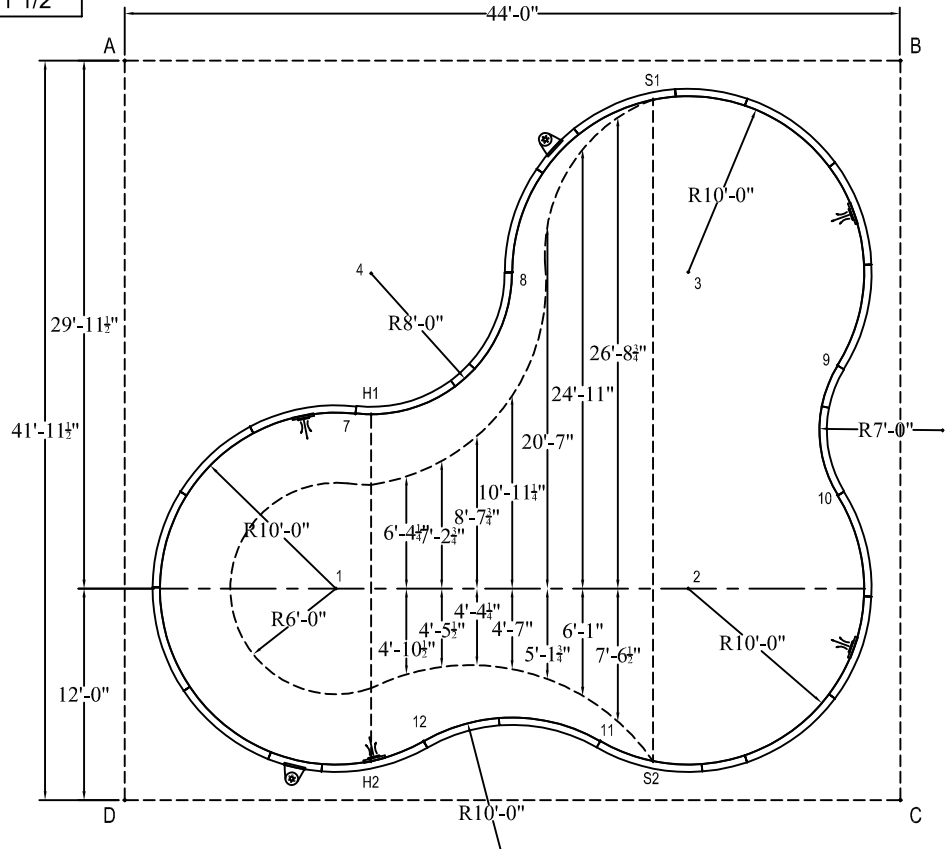

6 to 8	35'-2 1/2"
6 to 9	35'-2 1/2"
6 to 10	29'-2 1/2"
6 to 11	10'-0"
6 to 12	10'-0"
7 to 8	11'-11"
7 to 9	27'-6"
7 to 10	27'-9 1/4"
7 to 11	23'-2 1/2"
7 to 12	19'-0"
8 to 9	19'-2 1/2"
8 to 10	22'-4 1/2"
8 to 11	27'-0 1/4"
8 to 12	27'-0 1/4"
9 to 10	7'-4 1/2"
9 to 11	25'-2 3/4"
9 to 12	31'-8 3/4"
10 to 11	19'-4 3/4"
10 to 12	27'-4"
11 to 12	10'-0 1/4"
S1 to S2	37'-6 3/4"
S1 to H1	23'-11 3/4"
S1 to H2	40'-9 3/4"
S2 to H1	25'-4 1/2"
S2 to H2	16'-0"
H1 to H2	19'-8 1/4"